



Erosion & Sediment Control

Prepared for: Town of Stratford

Prepared by: IDEA Group Inc.

March 21, 2022

TABLE OF CONTENTS

1.0 INTRODUCTION	4
1.1 Objective	4
1.2 Responsibilities	4
2.0 DEFINITIONS	4
3.0 REGULATORY REQUIREMENTS	6
3.1 Provincial & Federal Regulations	6
3.2 Municipal Legislation & Bylaws	7
ZONING AND DEVELOPMENT BYLAW	7
3.3 Watershed	7
4.0 EROSION & SEDIMENT CONTROL PLANS	8
4.1 Overview	8
4.1.1 TYPE 1 PROJECT:	8
4.1.2 TYPE 2 PROJECT:	8
4.2 ESC Best Practices	8
4.3 ESC Drawing(s)	9
4.4 RUSLEFAC	9
4.4.1 ANNUAL SOIL LOSS (A VALUE)	10
4.4.2 RAINFALL AND EROSION (R VALUE)	10
4.4.3 SOIL ERODIBILITY FACTOR (K VALUE)	10
4.4.4 TOPOGRAPHIC/SLOPE FACTOR (LS VALUE)	10
4.4.5 GROUND COVER FACTOR (C VALUE)	10
4.4.6 PRACTICE FACTOR (P VALUE)	11
5.0 TABLES	12
TABLE 1.0 - RAINFALL FACTOR (R-VALUE)	13
TABLE 2.0 - SOIL ERODIBILITY (K-VALUE)	14
TABLE 3.0 - LS3 - TOPOGRAPHIC/SLOPE FACTOR FOR CONSTRUCTION SITES (LS-VALUE)	15
TABLE 3.1 - LS4 - TOPOGRAPHIC/SLOPE FACTOR FOR THAWING SOILS (LS-VALUE)	16
TABLE 4.0 - GROUND COVER FACTOR (C-VALUES)	17
TABLE 5.0 - PRACTICE FACTOR (P-VALUES)	18

EROSION & SEDIMENT CONTROL GUIDELINE

TABLE 6.0 - SOIL PARTICULATE SETTLING TIMES	18
6.0 FIGURES	19
FIGURE A - ISOERODENT MAP	20
FIGURE B - STRUCTURE TYPE NOMOGRAPH	21
FIGURE C - PERMEABILITY NOMOGRAPH	22
FIGURE D - SOIL ERODIBILITY NOMOGRAPH (K VALUE)	23
7.0 RUSLEFAC CALCULATION EXAMPLE	24
R VALUE (4.4.2)	24
K VALUE DETERMINATION (4.4.3)	24
FIGURE 7.1 - EXAMPLE SIEVE PARTICLE SIZE ANALYSIS	24
FIGURE 7.2 - SOIL STRUCTURE BASED ON SOIL TEXTURE	25
FIGURE 7.3 - SOIL PERMEABILITY BASED ON SOIL TEXTURE	26
FIGURE 7.4 - SOIL ERODIBILITY NOMOGRAPH	27
LS VALUE (4.4.4)	28
C VALUE DETERMINATION (4.4.5)	29
P VALUE DETERMINATION (4.4.6)	29
FIGURE 7.5 - SAMPLE RUSLEFAC CALCULATION	30
8.0 SAMPLE DRAWING/ESC PLAN	31
9.0 STANDARD DETAILS	33
APPENDIX A:	43
Stratford Area Watershed Improvement Group Water Sampling Procedure	43
WATER SAMPLING PROCEDURE	44
CCME GUIDELINES	45

1.0 INTRODUCTION

1.1 Objective

Soil erosion continues to cause issues for the development industry and local watersheds on Prince Edward Island. The following guideline is provided as a means to standardize the design and implementation of Erosion and Sediment Control (ESC) practices and procedures on development/construction sites. This guideline also forms the basis for the review and approval of ESC Plans by The Town of Stratford. As described in **Section 4.0** the Revised Universal Soil Loss Equation For Application in Canada (RUSLEFAC) is the proposed standardized method for developing ESC Plans.

1.2 Responsibilities

The **owner** is ultimately responsible for the implementation of and compliance with the approved ESC Plan for their site. The ESC application and/or drawings should be completed by a qualified **designer** (P.Eng or CP-ESC) for approval by the local authority. The **project manager** serves as the owner's representative and shall delegate tasks to the contractors for implementation and inspection of ESC measures. The **contractor** must understand and follow the approved ESC Plan. The contractor and project manager should monitor site conditions and communicate proposed amendments or revisions to the designer prior to implementation. Any designer approved changes must be submitted to the approving authority.

2.0 DEFINITIONS

For the purpose of this document, all words shall carry their customary definition unless defined otherwise. In this document:

- Contractor:** Refers to the active contractor on site. Generally this will refer to the contractor completing civil works such as utility installations, site grading and surface works.
- Critical Area:** Critical areas refer to all areas that can be significantly impacted in a negative way by erosion and sedimentation from the subject property. Examples of critical areas include but are not limited to: existing developments, public roadways, **watercourses** and **Natural areas**.
- Designer:** Consulting Engineer (P.Eng.) or Certified Professional in Erosion and Sediment Control (CPESC) that provided and stamped the erosion & sedimentation control plans.

Development:	Refers to any disturbance to existing ground in order to complete the work described in the development permit.
Heavy Rain Event:	More than 20mm of rain in a 12-hour period.
Natural areas:	As defined in Natural Areas Protection Act, natural areas shall include those areas that: <ol style="list-style-type: none">1. contain natural ecosystems or constitutes the habitat of rare, endangered or uncommon plant or animal species,2. contain unusual botanical, zoological, geological, morphological or paleontological features,3. exhibits exceptional and diversified scenery,4. provides haven for seasonal concentrations of birds and animals, or5. provides opportunities for scientific and educational programs in aspects of the natural environment.
Owner:	The land owner for the subject development.
Project Manager:	The representative of the project owner , responsible for direct contact with the approving authority. The PM must be identified in the ESC application with contact information.
Runoff:	Overland flow visibly carrying suspended sediment or flow leaving a development site.
Watercourse:	Watercourse shall include: <ul style="list-style-type: none">• Wetlands• 15m buffer/riparian areas• Sensitive ecosystem• Rivers, lakes & ponds
When possible:	When the time required to carry out an action does not directly prevent SAWIG staff attending a scheduled meeting, submitting a funding application, or carrying out a time-sensitive task.

3.0 REGULATORY REQUIREMENTS

3.1 Provincial & Federal Regulations

Current versions of all provincial acts, regulations and codes must be adhered to during all construction activities on site.

Federal legislation related to erosion and sediment control:

- Fisheries Act

Provincial legislation including the **Municipal Government Act**, **Environmental Protection Act** and **Water Act** work to protect our waterways from contamination, which includes sedimentation due to runoff and erosion.

Below is a brief description of the parts of each Act that apply to erosion and sediment control.

Municipal Government Act (MGA)

The Town of Stratford has power under Part 7, Division 2, Section 180 (m) and (s) of the Municipal Government Act to introduce a bylaw regarding erosion and sediment control, and to enforce any requirements under the bylaw to ensure the health and safety of our freshwater is maintained.

Environmental Protection Act (EPA)

Sediment can be a contaminant, as per the definition of 'contaminant' in the Environmental Protection Act (EPA). The EPA also defines 'environment', which includes air, land and water. Under Section 7 (2), the Minister or an environment officer can issue an environmental protection order if they have reasonable grounds that a contaminant has been, is being, or is going to be discharged into the environment or if it is necessary or advisable for the protection of the environment.

(EPA) Watercourse and Wetland Protection Regulations

The Watercourse and Wetland Protection regulations under the Environmental Protection Act state that no person shall dump or infill, or deposit soil, water, mud, sand, gravel, stones, rubbish, litter, rocks, aggregate or material or objects of any kind into a watercourse or wetland in Part 2, Section 2.

Water Act

The Water Act allows the Province to issue a water protection order in the case that a particular site is contributing a contaminant to the water system under Part 3, Section 22. The Water Act also specifically defines aquatic ecosystem and one of the goals of the Act is to make decisions that protect the security of aquatic ecosystems and the integrity of wetlands in Part 1, Section 2 (i).

3.2 Municipal Legislation & Bylaws

The Town of Stratford does not yet have a bylaw specifically related to erosion and sediment control but some of the provisions in our Zoning and Development Bylaw apply to this issue.

Zoning and Development Bylaw

Stratford Zoning Bylaw 4.13.3

The Development Officer may require such other information as may reasonably be required to assess the impact of any Subdivision, including but not limited to the following:

- a) a written assessment by the Province on any potential environmental impacts, including any requirements imposed by provincial legislation or regulations;
- b) a storm water management plan prepared by a licensed professional engineer;
- c) any other studies or documentation required by the Development Officer in order to adequately assess the impact of the proposed subdivision.

Part 8 – General Provisions for All Zones

Stratford currently requires stormwater management plans for major subdivisions (5 lots or more) and for large development applications.

3.3 Watershed

The Stratford Area Watershed Improvement Group (SAWIG) carries out annual long-term water quality monitoring in the Stratford area. Since 2016 SAWIG has collected baseline information from predetermined monitoring locations collecting parameters such as nutrient concentration, temperature, dissolved oxygen, total dissolved solids, pH, conductivity, and flow.

SAWIG uses a few monitoring techniques to conduct water quality monitoring including weekly field monitoring using a YSI Pro2030 and flow probe (Global Water FP111), bi-weekly sample collection for lab analysis of total nitrogen (WCM_05M) and total phosphorus (WCL_08M), and the continuous deployment of HOBO data loggers (HOBO Dissolved Oxygen Data Logger and HOBO TidbiT MX) to collect dissolved oxygen and temperature data.

This data is shared publicly and can be viewed at this open source data website: <https://atlanticdatastream.ca>

In 2021 through the support of the EcoAction Community Funding Program, SAWIG designed a sampling procedure to implement during spring, summer, and fall, for the purpose of mitigating the effects of heavy rainfall on exposed soil and providing evidence of the negative environmental effects of runoff. This procedure is included in **Appendix A**.

4.0 EROSION & SEDIMENT CONTROL PLANS

4.1 Overview

The owner is ultimately responsible for their construction site. In order to protect downstream properties, adjacent waterways, and storm infrastructure from soil erosion and unwanted sediment, the owner is required to obtain an approved ESC plan prior to commencing stripping and grading activities. The size of the site, potential for erosion, and proximity to critical areas will determine the ESC plan requirements.

4.1.1 Type 1 Project:

- Less than 0.4 hectares (ha) of soil disturbance.
- No critical areas in close proximity.

Type 1 projects are required to follow the ESC best practices as outlined in Section 4.2

4.1.2 Type 2 Project:

- Greater than 0.4 hectares (ha) of soil disturbance or adjacent to a **critical area**.

Type 2 projects are required to submit a full ESC Plan for approval prior to initiating stripping and grading.

4.2 ESC Best Practices

The following general notes and best practices are the minimum requirements for all construction sites.

1. **Do not remove or disturb vegetation outside the development permit approved area of construction.**
2. **Stabilize access roads as soon as possible.**
3. **Erosion control measures must be checked on a regular basis. A minimum of every 7 days or immediately following a heavy rainfall event.**
4. **All measures must be taken by the general contractor to prevent any sedimentation from leaving the site during construction.**
5. **Any mud or debris that is tracked onto the public roadway must be cleaned off by the end of each work day.**
6. **Failure to comply with the erosion and sediment control guidelines or requirements may result in a stop work order until corrective actions have been implemented to the satisfaction of the approving authority.**

- Type 1 Projects shall include these general notes on the Site Drainage/Grading Plan.
- Type 2 Projects shall include these general notes on the ESC Plan.

4.3 ESC Drawing(s)

Only Type 2 projects require the submission and approval of a detailed ESC drawing. Refer to **Section 8.0** for sample ESC drawings.

ESC drawings, at a minimum must include:

1. **The best practices general notes listed in Section 4.2. The designer should add any additional notes deemed necessary for the project site.**
2. **Surface contours at a minimum interval of 0.5 meters. Contour interval should be increased as needed to accurately represent the grading design.**
3. **Drainage/Catchment areas including:**
 - a. **Catchment identifier**
 - b. **Catchment area slope gradient and length.**
 - c. **LS value for RUSLEFAC calculations (Section 4.4).**
4. **Project boundary (grading limits, development permit, or site boundary).**
5. **Proposed stockpile location(s).**
6. **Proposed sedimentation pond locations, dimensions and volumes.**
7. **RUSLEFAC Calculations (Section 4.4)**
8. **Proposed ESC measures (silt fence, hydro-seed, etc.)**

4.4 RUSLEFAC

The Revised Universal Soil Loss Equation for Application in Canada (RUSLEFAC) is an equation used to estimate potential soil loss under site specific conditions. RUSLEFAC provides a standardized method for designing and reviewing ESC Plans. The designer can use this method to identify problem areas and to select appropriate practices or measures to reduce the soil loss to an acceptable level. The acceptable level is defined as **4/tonnes/ha/yr** for any given slope.

RUSLEFAC calculates the annual soil loss due to erosion in Tonnes/Hectare/Year based on the input from the designer. The formula is as follows:

$$A = R \times K \times LS \times C \times P$$

A	=	Annual soil loss due to erosion (t/ha/y)
R	=	Rainfall factor or Erosivity index for the project location (1520 Charlottetown PE) (<i>Table 1.0</i>)
K	=	Soil Erodibility Factor based on the soil characteristics at the site
LS	=	Topographic slope factor based on catchment area slope gradient and length
C	=	Cover factor
P	=	Protective measure factor

4.4.1 Annual Soil Loss (A Value)

Construction sites in The Town of Stratford must ensure that soil loss is reduced below **4.0 tonnes/ha/yr** for each catchment area on site. The use of the RUSLEFAC calculation will help determine the required practices to achieve this threshold.

4.4.2 Rainfall and Erosivity (R Value)

The R value is a function of climate data such as historical rainfall records and storm data. The total amount of rainfall and the intensity of the rainfall dictates the potential erosivity. The R-value for Charlottetown PEI, as defined in the Agri-Food RUSLE Handbook is **1520** and should be used for all RUSLEFAC calculations on PEI. Refer to Figure A and Table 1.0 for additional information.

4.4.3 Soil Erodibility Factor (K Value)

The K value represents the rate of erodibility of the subject soil present at the construction site. The K value is defined as the rate of soil loss per unit area (3.7mx22m) plot. The lower the K-value, the less susceptible the soil is to erosion.

The **soil permeability, structure**, and the **percentage of sand, silt, and clay** in the soil are required information in order to determine the K value for the project. The required soil information should be provided in the project Geotechnical Investigation. It is at the geotechnical engineers direction as to how many soil samples are required to determine the soil characters for the given site. With the required information, the designer or geotechnical engineer can reference the included nomographs (**Figure B and C**) and calculate the appropriate K value for the RUSLEFAC calculations.

If the geotechnical information is not available, a worst case scenario K value of 0.060 must be used.

4.4.4 Topographic/Slope Factor (LS Value)

The LS value accounts for the slope severity and length of the slope being analyzed. As sites will have varied slope patterns and lengths, a critical LS value will need to be identified for each catchment area on the site. The designer should label the slope gradient, length and applicable LS value as determined from Table 3.0 or 3.1 on the ESC Plans.

4.4.5 Ground Cover Factor (C Value)

In order to limit erosion potential on construction sites, ground cover measures (C Value) such as: sod, hydro-seed, rolled erosion blankets, spray products, etc. can be applied to exposed surfaces. Given PEI's high clay and sand composition, **soil stabilization and ground cover measures will provide the most effective control**

against erosion and sedimentation. Ground cover measures specified, and the C value used by the designer, must be supported by the manufacturer's specifications.

4.4.6 Practice Factor (P Value)

As mentioned above, ground cover should be the prioritized control method as it reduces the production of sediment and therefore the need to contain it. When cover protection measures are insufficient, additional practice measures (P value) will be provided. Practice methods can be divided into two categories:

1. **Filter Controls:** Water is passed through a porous media to filter out sediments. This works well for large particles and low volume, low velocity runoff but does not effectively treat water during high intensity rain events or thunderstorms when erosion is maximized.
2. **Settling:** Sediment ponds allow for sediment laden water to reduce velocity and for particles to settle out of suspension over time. PEI has a high soil ratio of fine materials which take a long time to settle. The addition of flocculants or coagulants can reduce the required settling time. Refer to Table 6.0 for the approximate settling time required for different particle sizes to settle 0.5m. The slow settling time associated with clay, further describes the need for ground cover to be prioritized. Additional structural practices such as vegetated buffer strips, surface roughening, silt fence, terracing or gravel filters can help aid in the reduction of erosion and sediment loss. Refer to Table 5.0 for applicable P Values associated with different practice factors.

The P value is the least accurate factor and subject to error. The provided P values in Table 5.0 can be applied to the RUSLEFAC design, however, the designer should prioritize the use of ground cover practices whenever possible.

With all required factors determined, individual catchment areas can be analyzed for erosion potential and the requirement for implementation of various protection measures.

The RUSLEFAC formula and process is further explained in the Agriculture & Agri-Food Canada document, *"RUSLEFAC Revised Universal Soil Loss Equation for Application in Canada - A Handbook for Estimating Soil Loss from Water Erosion in Canada"*.

5.0 TABLES

Table 1.0 - Rainfall Factor (**R**-Value)

SITE	MONTHLY PERCENTAGE OF EROSION INDEX (R)												
	R	J	F	M	A	M	J	J	A	S	O	N	D
Beaverlodge, B.C.	378	0	0	4	9	3	20	23	34	7	0	0	0
Lethbridge, Alta.	346	0	0	1	4	11	22	37	16	10	0	0	0
Peace River, Alta.	226	0	0	4	10	5	17	41	17	7	1	0	0
Vauxhall, Alta.	270	0	0	2	13	9	24	24	16	11	0	0	0
Broadview, Sask.	342	0	0	2	7	8	12	24	31	15	2	0	0
Estevan, Sask.	680	0	0	1	2	8	22	41	18	9	1	0	0
Outlook, Sask.	261	0	0	1	4	8	39	32	12	5	0	0	0
Saskatoon, Sask.	348	0	0	2	6	13	38	33	5	3	0	0	0
Swift Current, Sask.	268	0	0	1	3	7	43	25	16	5	0	0	0
Wynyard, Sask.	572	0	0	1	2	13	18	39	22	4	1	0	0
Yorkton, Sask.	663	0	0	1	2	7	23	26	28	10	2	0	0
Hudson Bay	510	0	0	2	5	5	22	37	18	10	1	0	0
Glenlea	1029	0	0	2	5	11	23	31	20	6	3	0	0
Gimli, Man.	848	0	0	1	4	6	25	24	27	11	3	0	0
Winnipeg, Man.	1093	0	0	1	3	12	18	21	32	12	2	0	0
White River, Ont.	1075	0	0	0	2	8	16	17	26	23	5	3	0
Windsor, Ont.	1615	2	3	5	9	6	15	20	18	9	5	4	4
London, Ont.	1330	3	3	3	9	7	14	18	15	11	7	6	4
Montreal, Que.	920	0	0	0	6	5	17	19	22	15	9	7	0
Moncton, N.B.	1225	3	4	4	4	8	10	14	15	10	12	11	5
Halifax, N.S.	1790	*	*	*	2	11	16	19	24	19	8	1	0
Kentville, N.S.	1975	4	6	7	6	3	12	12	15	10	10	7	8
Nappan, N.S.	1900	3	3	3	9	7	14	18	15	11	7	6	4
Truro, N.S.	2000	4	8	5	5	5	7	6	13	11	11	15	10
Charlottetown, P.E.I.	1520	4	4	4	9	7	13	17	14	11	7	5	5
St. John's, Nfld.	1700	4	8	5	5	5	7	6	13	11	11	17	8

Source Agriculture and Agri-Food Canada RUSLEFAC a Handbook for Estimating Soil Loss from Water Erosion in Canada.

Table 2.0 - Soil Erodibility (**K**-Value)

TEXTURAL CLASS	ORGANIC MATTER		
	< 2%	>2%	AVERAGE
Clay	0.032	0.028	0.029
Clay Loam	0.044	0.037	0.040
Coarse Sandy Loam	-	0.009	0.009
Fine Sand	0.012	0.008	0.011
Fine Sandy Loam	0.029	0.022	0.024
Heavy Clay	0.025	0.020	0.022
Loam	0.045	0.038	0.040
Loamy Fine Sand	0.020	0.012	0.015
Loamy Sand	0.007	0.005	0.005
Loamy Very Fine Sand	0.058	0.033	0.051
Sand	0.001	0.003	0.001
Sandy Clay Loam	-	0.026	0.026
Sandy Loam	0.018	0.016	0.017
Silt Loam	0.054	0.049	0.050
Silty Clay	0.036	0.034	0.034
Silty Clay Loam	0.046	0.040	0.042
Very Fine Sand	0.061	0.049	0.057
Very Fine Sandy Loam	0.054	0.044	0.046

Source Agriculture and Agri-Food Canada RUSLEFAC a Handbook for Estimating Soil Loss from Water Erosion in Canada

Table 3.0 - LS3 - Topographic/Slope Factor for Construction Sites (**LS**-Value)

SLOPE (%)	50											
	2	5	10	15	25	50	75	100	150	200	250	300
0.2	0.04	0.04	0.04	0.04	0.04	0.04	0.05	0.05	0.05	0.05	0.05	0.05
0.5	0.06	0.07	0.08	0.08	0.08	0.09	0.10	0.10	0.11	0.12	0.12	0.12
1	0.07	0.09	0.11	0.14	0.14	0.17	0.19	0.20	0.23	0.24	0.26	0.27
2	0.10	0.14	0.18	0.26	0.26	0.34	0.40	0.44	0.52	0.58	0.64	0.69
3	0.11	0.17	0.24	0.37	0.37	0.52	0.63	0.72	0.87	1.00	1.11	1.22
4	0.13	0.21	0.30	0.49	0.49	0.70	0.87	1.02	1.26	1.47	1.65	1.82
5	0.14	0.24	0.36	0.61	0.61	0.91	1.14	1.35	1.70	2.00	2.28	2.53
6	0.16	0.27	0.42	0.72	0.72	1.10	1.41	1.67	2.14	2.54	2.91	3.25
8	0.19	0.34	0.53	0.96	0.96	1.50	1.96	2.36	3.07	3.70	4.28	4.82
10	0.21	0.40	0.64	1.19	1.19	1.92	2.53	3.08	4.06	4.94	5.75	6.52
12	0.27	0.52	0.85	1.63	1.63	2.66	3.54	4.33	5.77	7.07	8.28	9.42
14	0.32	0.62	1.02	1.98	1.98	3.28	4.40	5.42	7.27	8.95	10.52	12.01
16	0.36	0.71	1.19	2.34	2.34	3.90	5.26	6.51	8.79	10.87	12.81	14.66
20	0.45	0.90	1.52	3.05	3.05	5.17	7.03	8.75	11.92	14.84	17.58	20.20
25	0.54	1.11	1.91	3.90	3.90	6.70	9.19	11.50	15.78	19.75	23.51	27.10
30	0.64	1.32	2.29	4.73	4.73	8.20	11.32	14.22	19.62	24.65	29.43	34.02
40	0.81	1.70	2.99	6.29	6.29	11.04	15.35	19.38	26.94	34.03	40.79	47.30
50	0.96	2.04	3.62	7.70	7.70	13.62	19.02	24.11	33.67	42.67	51.29	59.60
60	1.09	2.35	4.17	8.94	8.94	15.92	22.30	28.33	39.70	50.43	60.72	70.66

Values for topographic factor (LS) for high ratio of rill:inter-rill erosion, such as highly disturbed soil conditions and freshly prepared construction sites with little or no cover (not applicable to thawing soils). - Source Agriculture and Agri-Food Canada RUSLEFAC a Handbook for Estimating Soil Loss from Water Erosion in Canada

Table 3.1 - LS4 - Topographic/Slope Factor for Thawing Soils (**LS**-Value)

SLOPE (%)	50											
	2	5	10	15	25	50	75	100	150	200	250	300
0.2	0.01	0.02	0.03	0.04	0.05	0.06	0.08	0.09	0.11	0.13	0.14	0.16
0.5	0.02	0.04	0.06	0.07	0.09	0.12	0.15	0.18	0.21	0.25	0.28	0.30
1	0.04	0.07	0.09	0.11	0.15	0.21	0.25	0.29	0.36	0.41	0.46	0.50
2	0.07	0.12	0.17	0.20	0.26	0.37	0.45	0.52	0.64	0.74	0.83	0.90
3	0.11	0.17	0.24	0.29	0.37	0.53	0.65	0.75	0.92	1.06	1.18	1.30
4	0.14	0.22	0.31	0.38	0.49	0.69	0.84	0.97	1.19	1.38	1.54	1.68
5	0.17	0.27	0.38	0.47	0.60	0.85	1.05	1.21	1.48	1.71	1.91	2.09
6	0.20	0.32	0.45	0.55	0.72	1.01	1.24	1.43	1.75	2.02	2.26	2.48
8	0.27	0.42	0.60	0.73	0.94	1.33	1.63	1.88	2.31	2.66	2.98	3.26
10	0.33	0.52	0.74	0.91	1.17	1.66	2.03	2.34	2.87	3.31	3.70	4.05
12	0.36	0.56	0.79	0.97	1.26	1.78	2.18	2.51	3.08	3.55	3.97	4.35
14	0.39	0.61	0.87	1.06	1.37	1.94	2.38	2.75	3.37	3.89	4.35	4.76
16	0.42	0.66	0.94	1.15	1.49	2.10	2.57	2.97	3.64	4.20	4.70	5.15
20	0.48	0.76	1.07	1.31	1.69	2.39	2.93	3.39	4.15	4.79	5.36	5.87
25	0.54	0.86	1.22	1.49	1.92	2.72	3.33	3.84	4.71	5.44	6.08	6.66
30	0.60	0.95	1.35	1.65	2.13	3.01	3.69	4.26	5.21	6.02	6.73	7.37
40	0.70	1.11	1.57	1.92	2.48	3.51	4.30	4.97	6.08	7.02	7.85	8.60
50	0.79	1.24	1.76	2.15	2.78	3.93	4.81	5.55	6.80	7.85	8.78	9.62
60	0.85	1.35	1.91	2.34	3.02	4.27	5.23	6.04	7.40	8.54	9.55	10.46

Values for topographic factor (LS) for thawing soils where most of the erosion is caused by surface flow (using $m=0.5$) - Source Agriculture and Agri-Food Canada RUSLEFAC a Handbook for Estimating Soil Loss from Water Erosion in Canada

Table 4.0 - Ground Cover Factor (C-Values)

COVER	MULCH RATE (TONS/ACRE)	LAND SLOPE (%)	C FACTOR	LENGTH LIMIT (M)
None	0	all	1	-
Straw or Hay	1	1-5	0.20	60
	1	6-10	0.20	30
	1.5	1-5	0.12	90
	1.5	6-10	0.12	45
	2	1-5	0.06	120
	2	6-10	0.06	60
	2	11-15	0.07	45
	2	16-20	0.11	30
	2	21-25	0.14	25
	2	26-33	0.17	15
Crushed Stone	135	< 16	0.05	60
	135	16-20	0.05	45
	135	21-33	0.05	30
	135	34-50	0.05	25
	240	< 21	0.02	90
	240	21-33	0.02	60
	240	34-50	0.02	45
Wood Chips	7	<16	0.08	25
	7	16-20	0.08	15
	12	<16	0.05	45
	12	16-20	0.05	30
	12	21-33	0.05	25
	25	<16	0.02	60
	25	16-20	0.02	45
	25	21-33	0.02	30
	25	34-50	0.02	25

Table 5.0 - Practice Factor (**P**-Values)

TREATMENT	SLOPE	SLOPE LENGTH	P	NOTES
Sediment Basin	-	-	0.5	250m ³ /ha
Silt Fence	-	-	0.6	
Vegetation Buffer	0-10%	-	0.6	
	11-24%	-	0.8	
Disked or Rough/ Irregular Surface	-	-	0.9	
Track Packing	1-2%	120	0.6	
	3-5%	90	0.5	
	6-8%	60	0.5	
	9-12%	40	0.6	
	13-16%	25	0.7	
	17-20%	20	0.8	
	>20%	15	0.8	

Table 6.0 - Soil Particulate Settling Times

PARTICLE SIZE	SETTLING VELOCITY	TIME TO SETTLE 0.5
Clay: dia. <0.002 mm	4.87 x 10 ⁻⁵ cm/s	285 hours
Silt (fine): dia. = 0.01 mm	4.90 x 10 ⁻³ cm/s	2.83 hours
Silt (coarse): dia. = 0.05 mm	1.22 x 10 ⁻¹ cm/s	13.6 minutes
Sand (fine): dia. = 0.10 mm	4.76 x 10 ⁻¹ cm/s	3.5 minutes

6.0 FIGURES

Figure A - Isoerodent Map

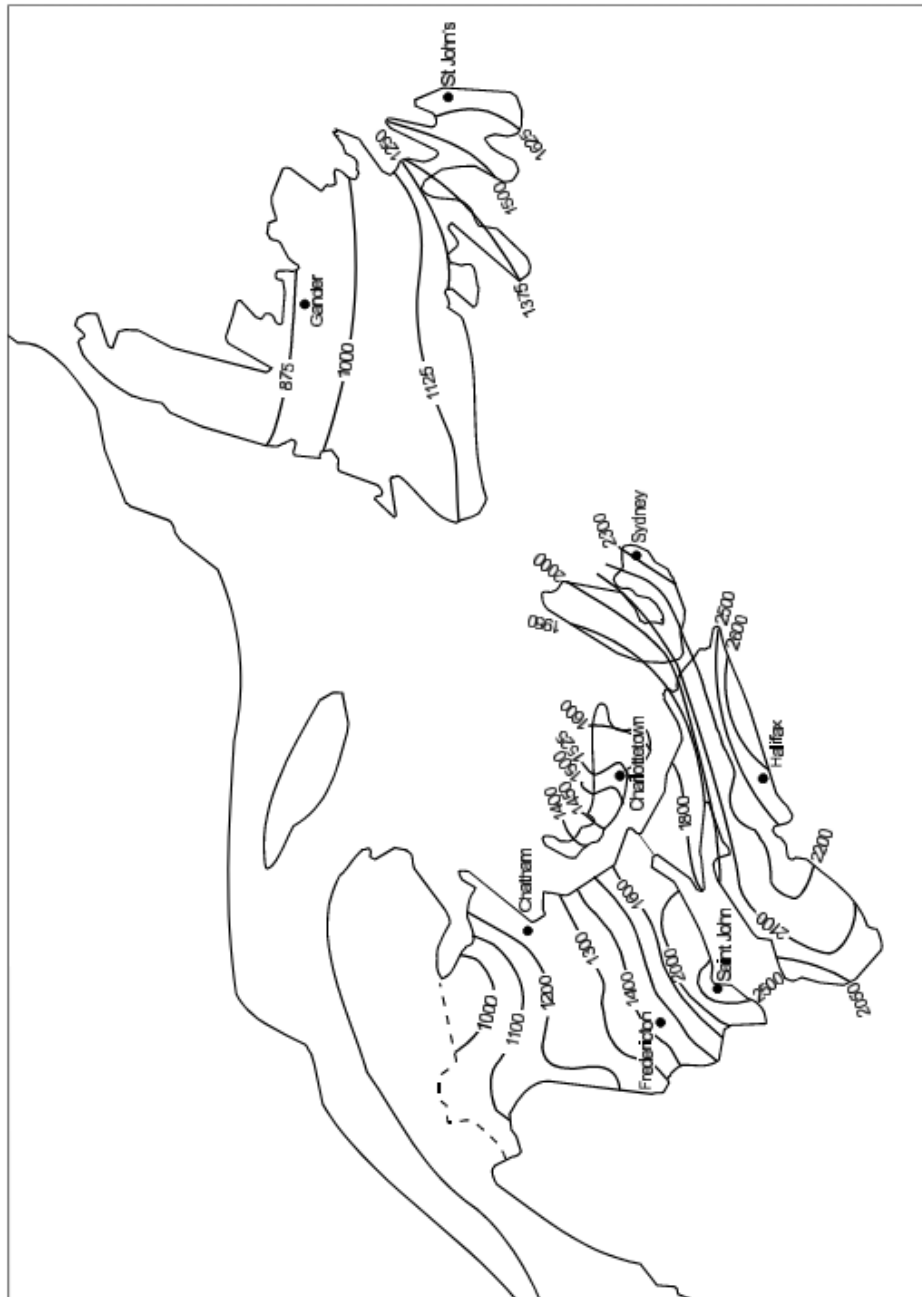

Figure B - Structure Type Nomograph

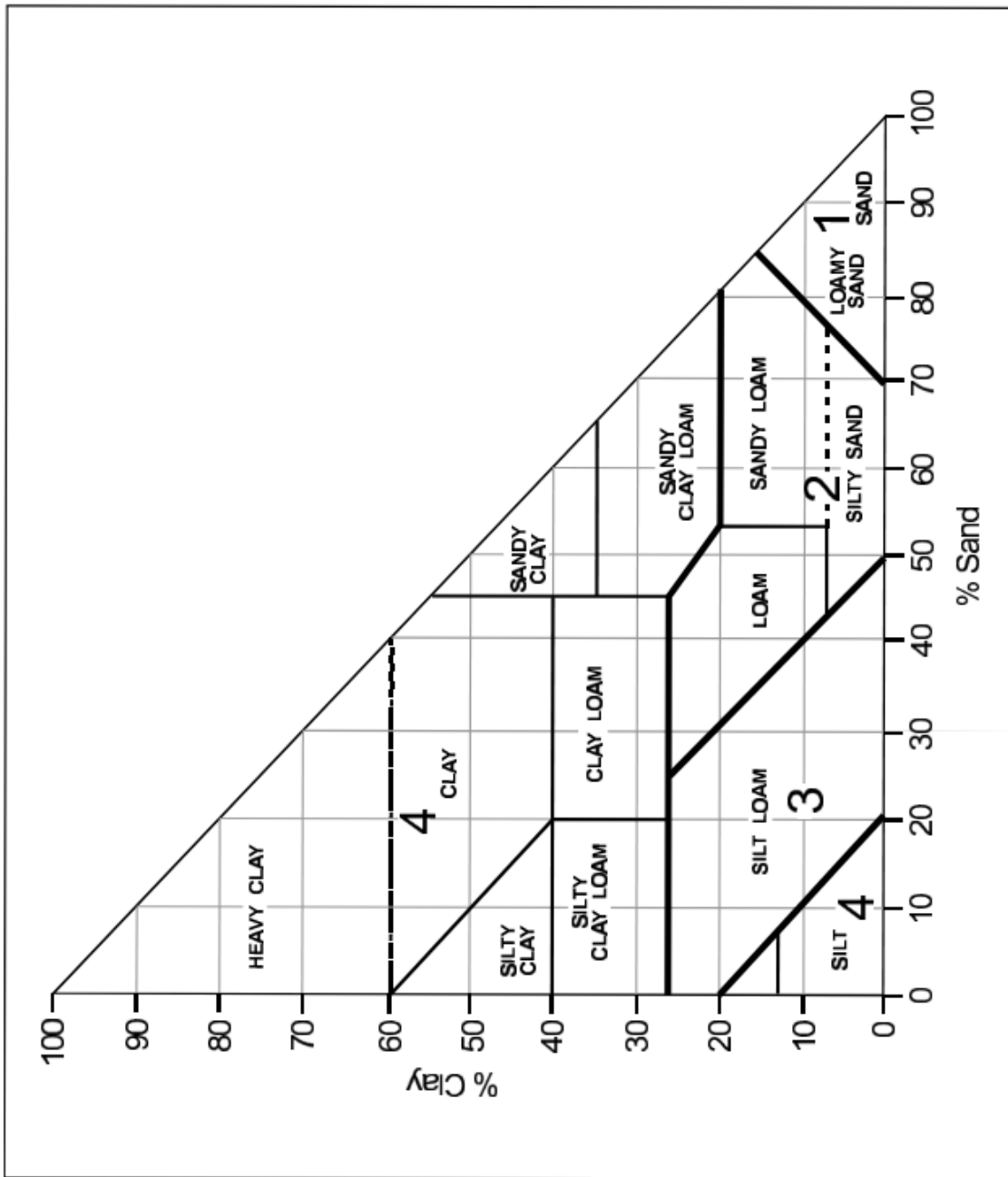

Figure C - Permeability Nomograph

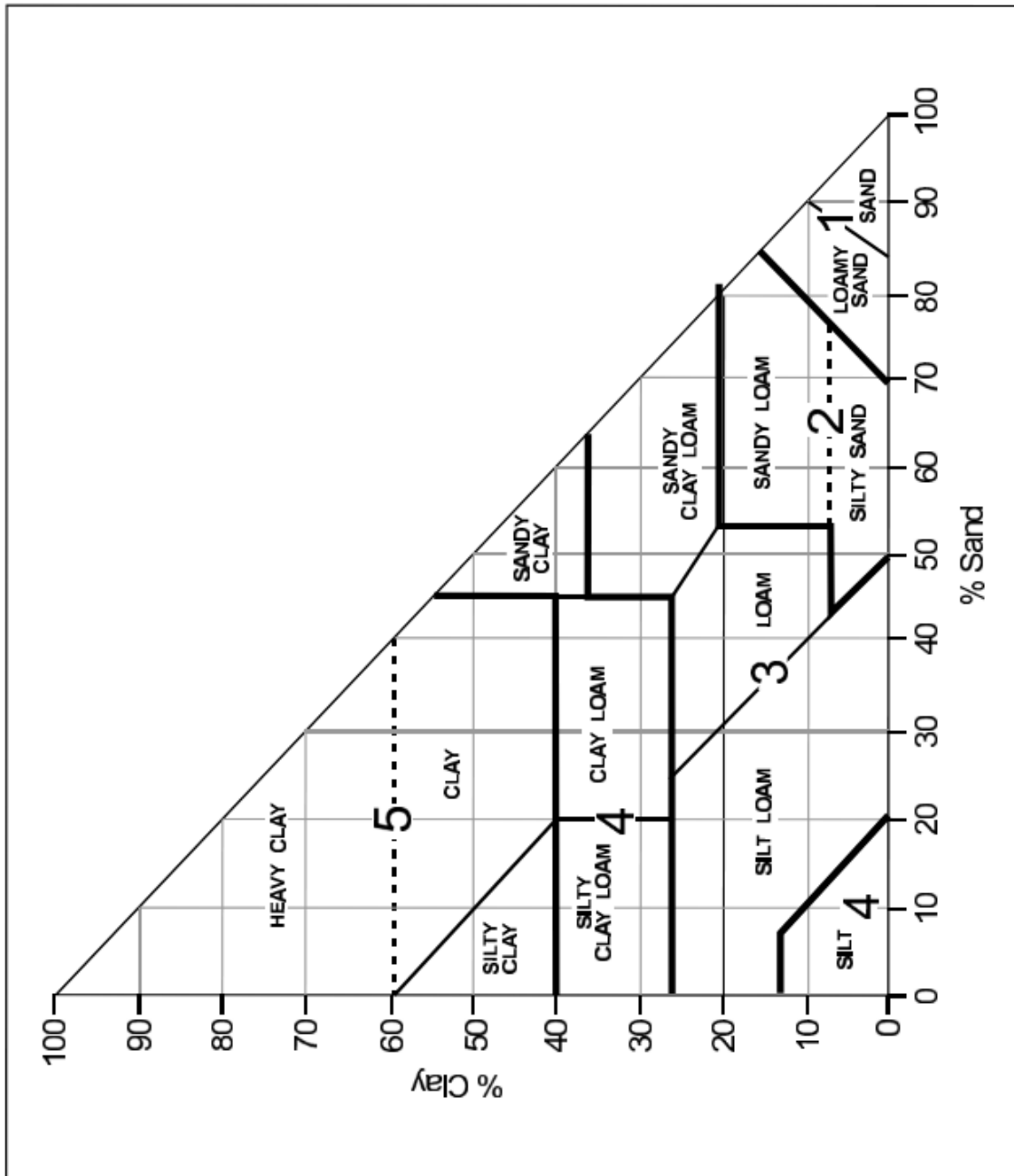
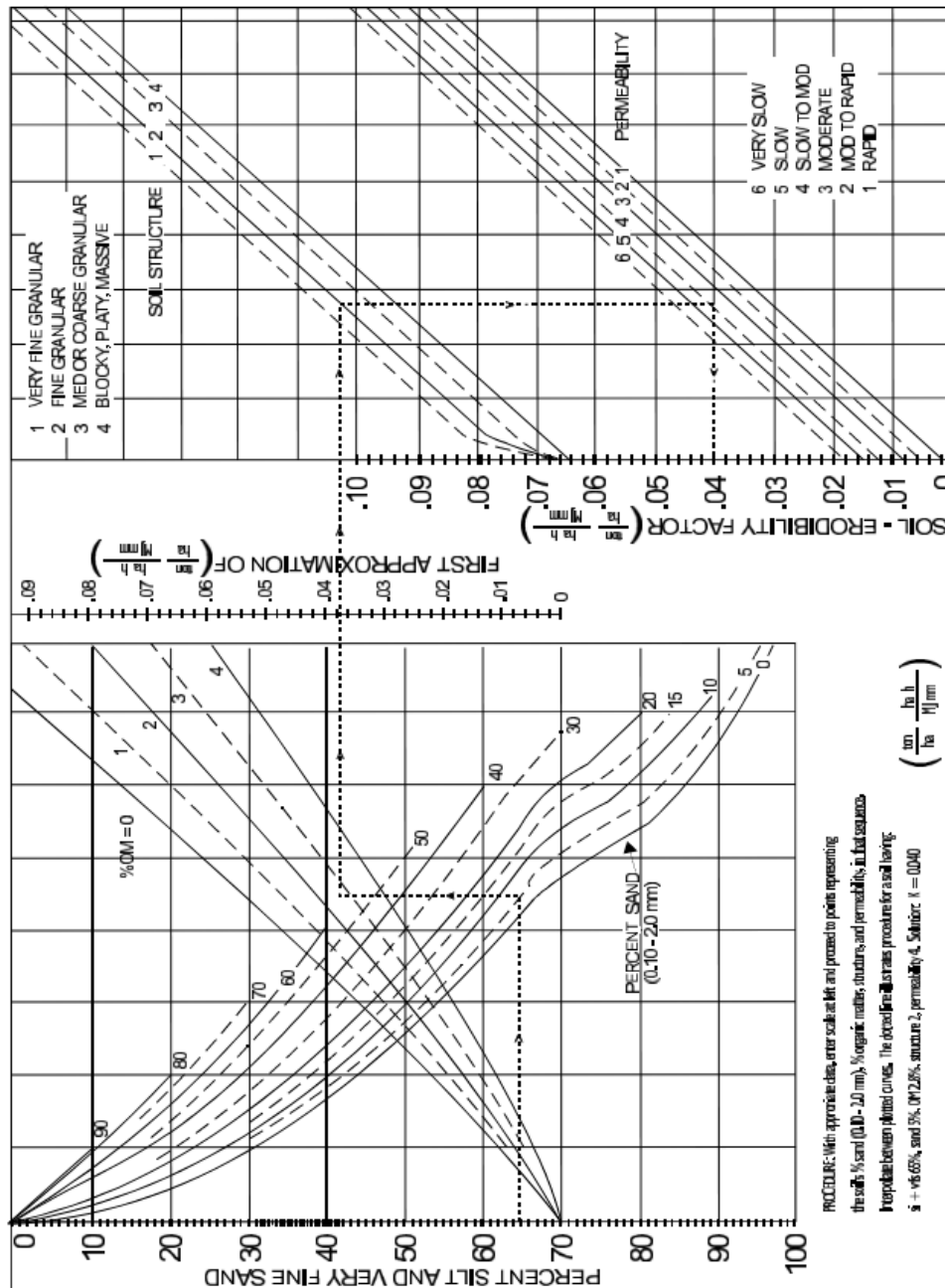

Figure D - Soil Erodibility Nomograph (K Value)



7.0 RUSLEFAC CALCULATION EXAMPLE

$$A = R \times K \times LS \times C \times P$$

R Value (4.4.2)

The R-value for Charlottetown PEI, as defined in the Agri-Food RUSLE Handbook is **1520**

K Value Determination (4.4.3)

Step 1: Determine the size of the particles for every soil type on the proposed site

The size of soil particles on site can be determined by using a sieve analysis or by manual methods used by trained ESC professionals. The following percentages are required:

- Percent (%) clay (less than 0.002mm diameter)
- Percent (%) silt and very fine sand in a sample by weight (0.002mm to 0.10mm diameter)
- Percent (%) sand by weight (0.10mm to 2.0mm diameter)
- Percent (%) organic matter (by weight)

FIGURE 7.1 - Example Sieve Particle Size Analysis

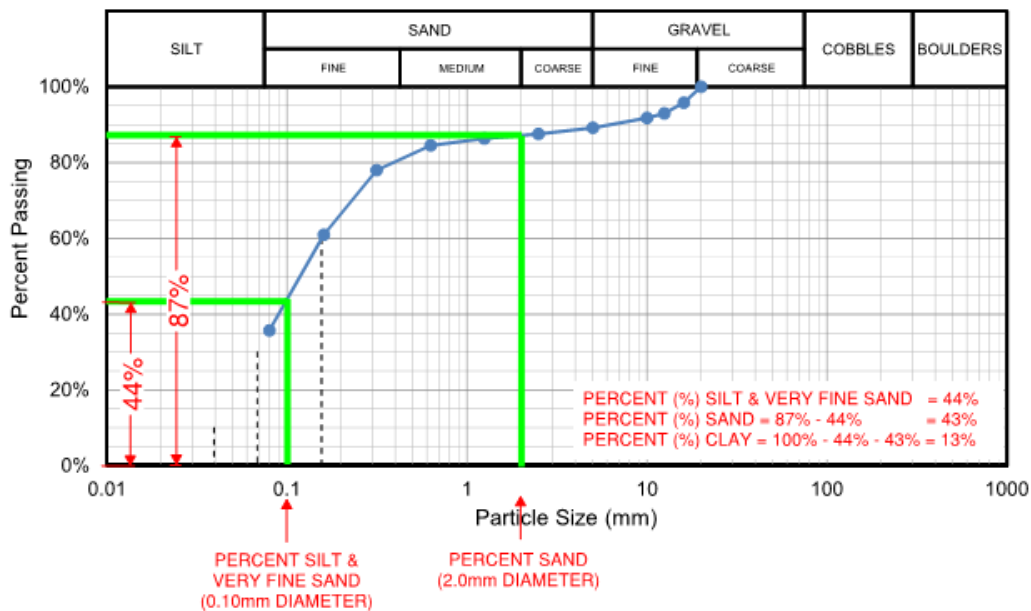
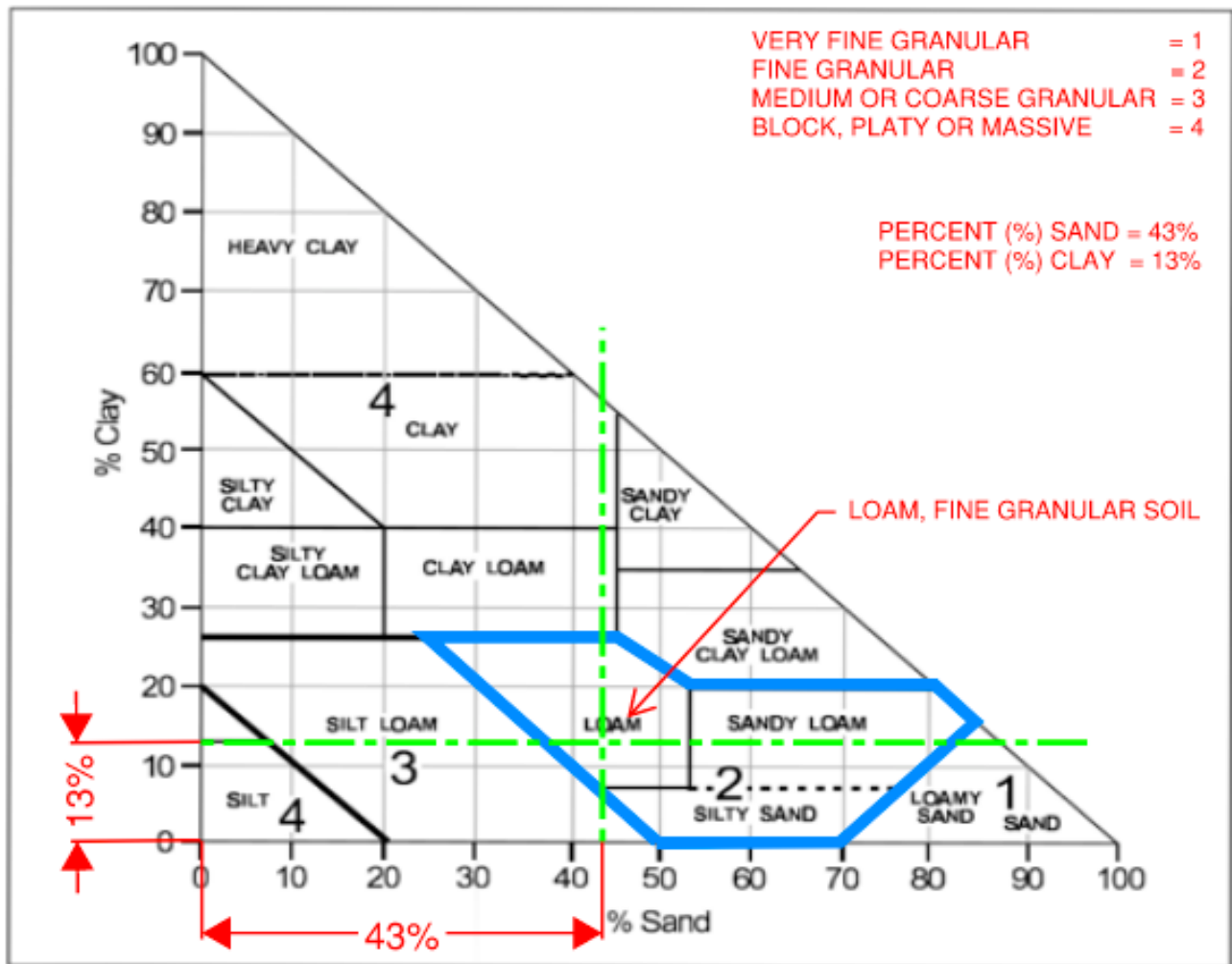

Figure 7.1 utilizes the sieve particle size analysis information provided by the geotechnical engineer to confirm the size of soil particles on site and calculate the **K Value**.

Step 2: Determine Soil Structure

Soil structure is determined by using the percent (%) sand (X-value) and percent (%) clay (Y-value) values calculated in the sieve particle size analysis (Figure 7.1). Using the Structure Type Nomograph (Figure 7.2) we can extrapolate the soil structure value.

FIGURE 7.2 - Soil Structure Based on Soil Texture



For the sample material with clay (13%) and sand (43%) soil composition, the intersection point yields a **Soil Structure Value of 2**, described as a **fine granular soil**.

Step 3: Determine Soil Permeability

Permeability of soil continues using the sand and clay percent (%) values that were generated in the sieve particle analysis (Figure 7.1). Using the Permeability Nomograph (Figure 7.3) we can extrapolate the soil permeability value.

FIGURE 7.3 - Soil Permeability Based on Soil Texture

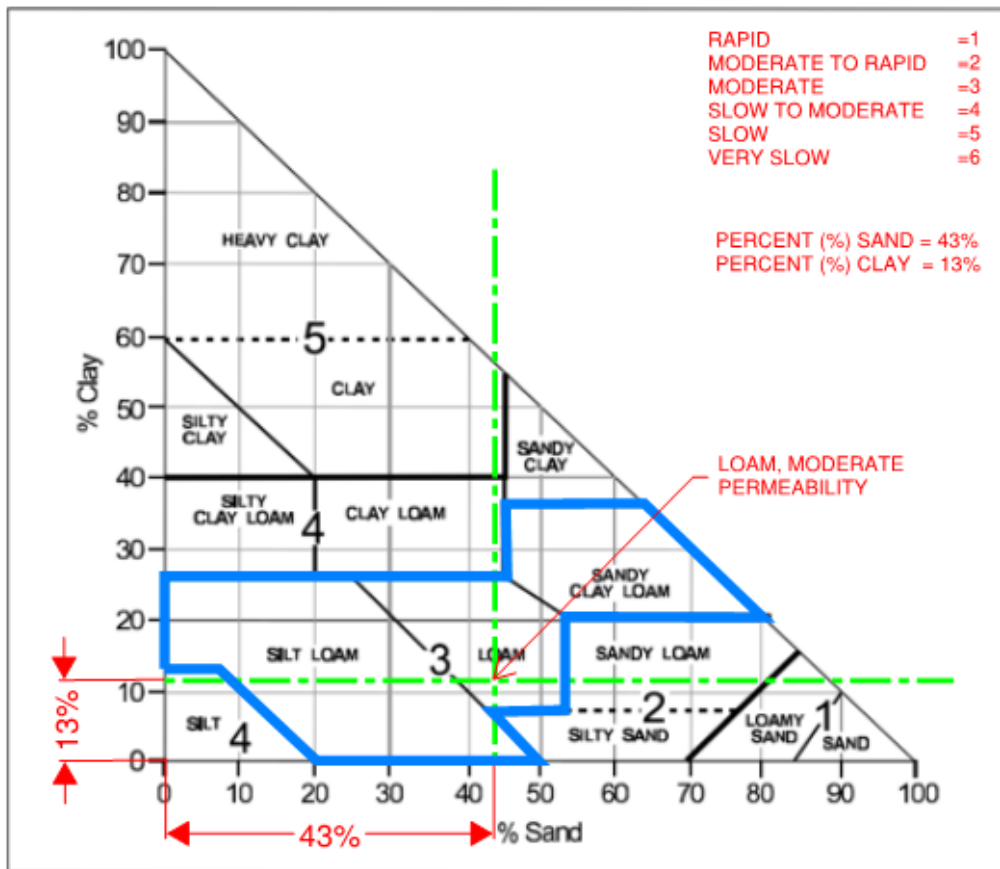

For the clay (13%) and sand (43%) soil composition, the intersection point yields a **Soil Permeability value of 3**, described as a **moderate permeability**.

Step 4: Determining Soil Erodibility

Using the Foster Nomograph (Figure 5.0 - D) in conjunction with the soil composition, soil structure and soil permeability values calculated in steps 1-3 the following graph interpolation yields the K-value.

Starting at the left side the graph, find the PERCENT SILT AND VERY FINE SAND mark (44%).

1. Move horizontally right across the nomograph until you intersect the PERCENT SAND mark (43%). Interpolation between curves is allowed.
2. Now move up vertically until you intersect the % OM (Organic Matter) (0% in this case).
3. Move horizontally to the right now.
4. Continue moving to the right until you intersect the SOIL STRUCTURE mark (Type 2, fine granular).
5. Move directly down until you hit the PERMEABILITY mark (3, moderate).
6. Now move to the left horizontally to find the SOIL ERODIBILITY FACTOR (final K-value) **(0.045)**.

FIGURE 7.4 - Soil Erodibility Nomograph

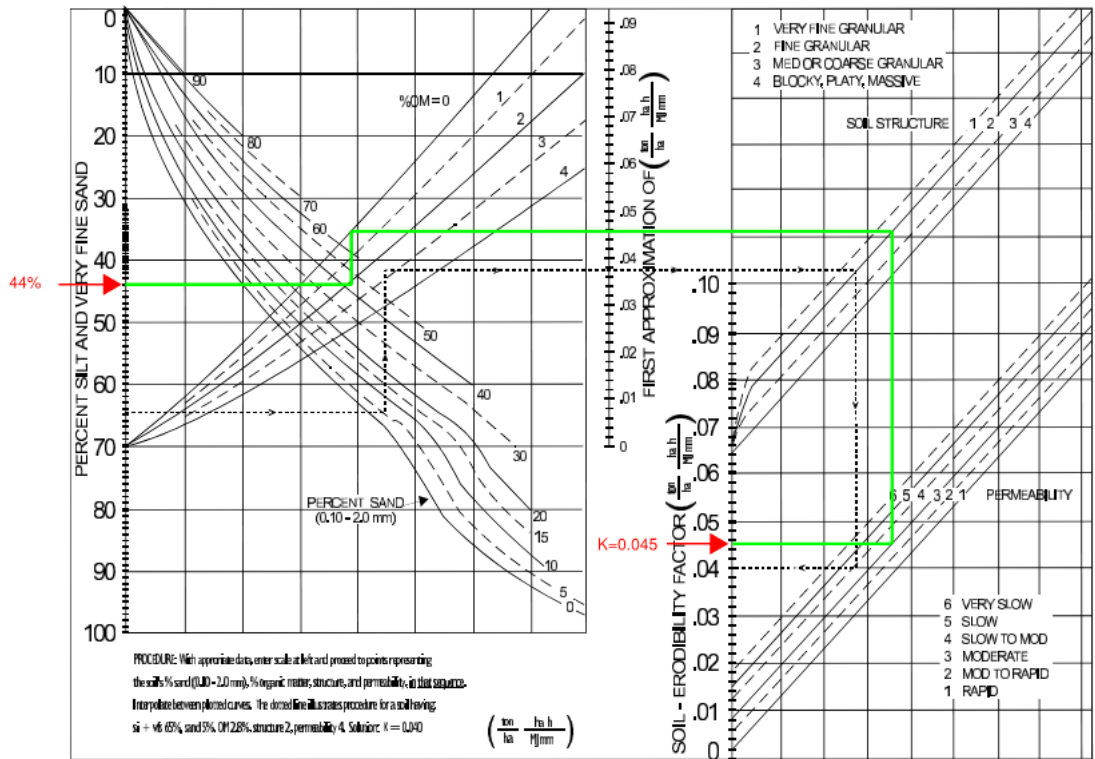

PERCENT (%) SILT & VERY FINE SAND = 44%
 PERCENT (%) SAND = 87% - 44% = 43%
 PERCENT (%) CLAY = 100% - 44% - 43% = 13%

ORGANIC MATTER = 0%
 SOIL STRUCTURE TYPE = 2
 PERMEABILITY = 3

LS Value (4.4.4)

The effect of topography on erosion in RUSLEFAC is accounted for by the LS-value.

Calculating slope requires the top and bottom of slope segments (meters) and the slope length (meters).

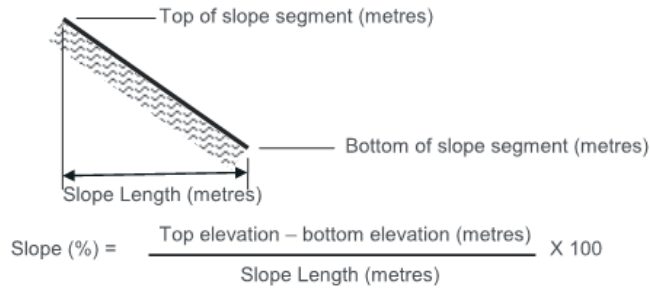

Example: A slope drops a distance of 1.5 m over a slope length of 25 m. The slope gradient is calculated as

$$\text{Slope (\%)} = (1.5/25) \times 100\% = 6.0\%$$

Using Table 3.0- Topographic/Slope Factor for Construction Sites, extrapolating the slope and slope length values yields an **LS-value of 0.72**.

Slope (%)	Slope length in meters											
	2	5	10	15	25	50	75	100	150	200	250	300
0.2	0.04	0.04	0.04	0.04	0.04	0.04	0.05	0.05	0.05	0.05	0.05	0.05
0.5	0.06	0.07	0.08	0.08	0.08	0.09	0.10	0.10	0.11	0.12	0.12	0.12
1	0.07	0.09	0.11	0.14	0.14	0.17	0.19	0.20	0.23	0.24	0.26	0.27
2	0.10	0.14	0.18	0.26	0.26	0.34	0.40	0.44	0.52	0.58	0.64	0.69
3	0.11	0.17	0.24	0.37	0.37	0.52	0.63	0.72	0.87	1.00	1.11	1.22
4	0.13	0.21	0.30	0.49	0.49	0.70	0.87	1.02	1.26	1.47	1.65	1.82
5	0.14	0.24	0.36	0.61	0.61	0.91	1.14	1.35	1.70	2.00	2.28	2.53
6	0.16	0.27	0.42	0.72	0.72	1.10	1.41	1.67	2.14	2.54	2.91	3.25
8	0.19	0.34	0.53	0.96	0.96	1.50	1.96	2.36	3.07	3.70	4.28	4.82
10	0.21	0.40	0.64	1.19	1.19	1.92	2.53	3.08	4.06	4.94	5.75	6.52
12	0.27	0.52	0.85	1.63	1.63	2.66	3.54	4.33	5.77	7.07	8.28	9.42
14	0.32	0.62	1.02	1.98	1.98	3.28	4.40	5.42	7.27	8.95	10.52	12.01
16	0.36	0.71	1.19	2.34	2.34	3.90	5.26	6.51	8.79	10.87	12.81	14.66
20	0.45	0.90	1.52	3.05	3.05	5.17	7.03	8.75	11.92	14.84	17.58	20.20
25	0.54	1.11	1.91	3.90	3.90	6.70	9.19	11.50	15.78	19.75	23.51	27.10
30	0.64	1.32	2.29	4.73	4.73	8.20	11.32	14.22	19.62	24.65	29.43	34.02
40	0.81	1.70	2.99	6.29	6.29	11.04	15.35	19.38	26.94	34.03	40.79	47.30
50	0.96	2.04	3.62	7.70	7.70	13.62	19.02	24.11	33.67	42.67	51.29	59.60
60	1.09	2.35	4.17	8.94	8.94	15.92	22.30	28.33	39.70	50.43	60.72	70.66

C Value Determination (4.4.5)

C-values will vary based on slope, application rate, material, construction details, and percent ground cover among other variables. Refer to product manufactures specification for product specific C-values.

Type of mulch	Mulch rate tons/acre	Land slope percent	C Factor	Length limit (feet)
None	0	all	1	-
Straw or hay, tied down by anchoring and tacking equipment	1	6-10	0.20	100
	1.5	1.5	0.12	300
	1.5	6-10	0.12	150
	2	1.5	0.06	400
	2	6-10	0.06	200
	2	11-15	0.07	150
	2	16-20	0.11	100
	2	21-25	0.14	75
	2	26-33	0.17	50
	2	34-50	0.20	35
Crushed stone, 1/4 to 1 1/2 inch	135	<16	0.05	200
	135	16-20	0.05	150
	135	21-33	0.05	100
	135	34-50	0.05	75
	240	<21	0.02	300
	240	21-33	0.02	200
	240	34-50	0.02	150
	240	34-50	0.02	150
Wood chips	7	<16	0.08	75
	7	16-20	0.08	50
	12	<16	0.05	150
	12	16-20	0.05	100
	12	21-33	0.05	75
	25	<16	0.02	200
	25	16-20	0.02	150
	25	21-33	0.02	100
25	34-50	0.02	75	

ECOanchor

Product Specifications

Property	Unit	Value
Appearance	-	Liquid
Colour	-	Milky White, Clear once cured
Bulk Density	g/cm ³	1.06-1.1
pH	pH	4-9
Flash Point	-	Non-flammable

Technical Info:

EcoAnchor – is a hydraulically applied copolymer designed for erosion control and dust suppression. This premiere product creates a three-dimensional (3D) structure in the upper 1-2 cm of soil to strengthen the soil and reduces the turbidity of soil run-off by keeping all soil particles in place. EcoAnchor outperforms traditional methods, including erosion blankets—and it does so at a fraction of the cost. Unlike mulch applications, EcoAnchor will not sheet off, but instead adheres to the soil.

Application Rates:

Endurance	Litres/Acre	C-Value
3 Months	284	0.08
6 Months	378	0.08
12 Months	473	0.08
18 Months	567	0.002
36 Months	1,041	0.001

Intended Uses:

Erosion Control, Dust Control, Sediment Control, Soil Tackifier, Soil Stabilizer

Dilution Rates:

EcoAnchor is to be diluted with water prior to the application. Add water to the application equipment prior to adding EcoAnchor concentrate, this will avoid foam from forming in the application equipment. Rinse application equipment with water following application to clean out pumps and remaining product.

EcoAnchor Dilution Rate: 8 parts : 1 part (Water:EcoAnchor)

Using the example tables and product specification sheets above, we can conclude that:

- **Straw Mulch @ 1 ton/acre (2500 kg/ha)** for slopes of **6-10%** provides a **C Factor of 0.20**.
- **Crushed Stone @ 1.35 ton/acre (3350 kg/ha)** for slopes **<16%** provides a **C Factor of 0.05**.
- **ECOanchor @ 378 litres/acre (935 litres/ha)** provides a **C Factor of 0.08**.

The designer is responsible to determine the most cost effective erosion control solution for their client.

P Value Determination (4.4.6)

Refer to product manufacturer's specifications and Table 5.0 for product specific P-values. As mentioned previously, Cover factor controls are the preferred method of erosion and sediment control. P-value measures such as silt fence, straw rolls, and surface roughening should be considered after cover factors have been reviewed and applied where possible. If multiple P-value measures are used, the total P-value is equal to the product of all the measures used. (eg. Silt fence $P=0.6$ paired with sediment pond of $P=0.1$ results in a total $P=0.06$).

FIGURE 7.5 - Sample RUSLEFAC Calculation

$$A = R * K * LS * C * P$$

Drawing Title:										
1	2	3	4	5	6	7	8	9	10	11
Drainage Area Identifier	LS Identifier	LS Area Size (Ha)	Slope and Slope Length (LS)	Controls and Practice in Place	R-Value	K-Value	LS-Value	C-Value	P-Value	A-Value (tonnes/ha*yr) *Must be below 2 tonnes/ha*yr
1	LS1	0.5	6% @ 25m	Mulch (crushed stone)	1320	0.045	0.72	0.05	1	2.14
2	LS2	0.23	3% @ 15m	EcoAnchor (spray solution)	1320	0.045	0.37	0.08	1	1.76
3	LS3	1.15	2% @ 25m	Mulch (straw)	1320	0.045	0.26	0.2	1	3.09
Total Site Size (Ha)		1.88								

8.0 SAMPLE DRAWING/ESC PLAN

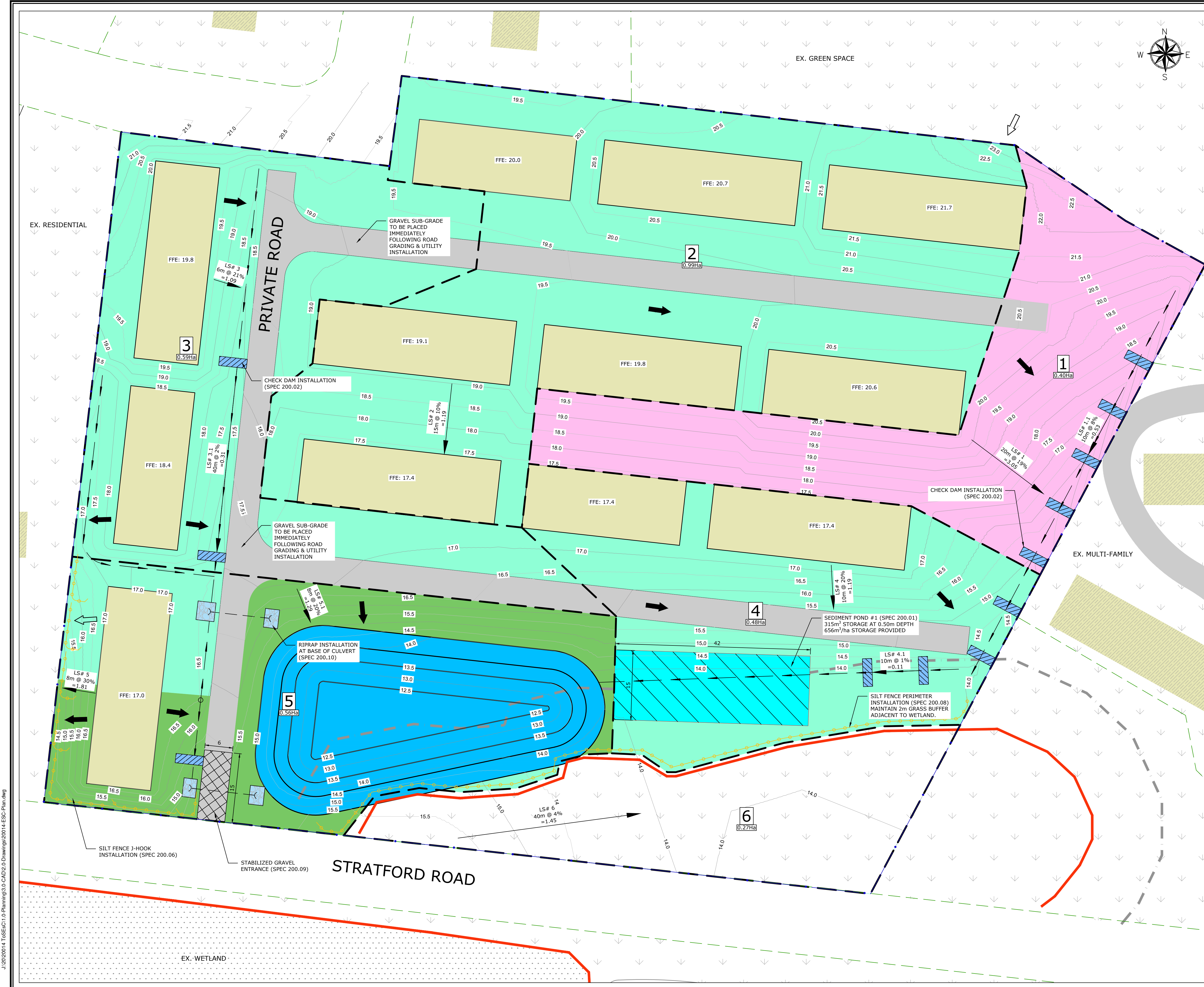

- GENERAL NOTES:**
- DO NOT REMOVE OR DISTURB VEGETATION OUTSIDE THE DEVELOPMENT PERMIT PROPOSED AREA OF CONSTRUCTION.
 - STABILIZE ACCESS ROADS AS SOON AS POSSIBLE.
 - EROSION CONTROL MEASURES MUST BE CHECKED ON A REGULAR BASIS. A MINIMUM OF EVERY 7 DAYS OR IMMEDIATELY FOLLOWING A HEAVY RAINFALL EVENT.
 - ALL MEASURES MUST BE TAKEN BY THE GENERAL CONTRACTOR TO PREVENT ANY SEDIMENTATION FROM LEAVING THE SITE DURING CONSTRUCTION.
 - ANY MUD OR DEBRIS THAT IS TRACKED ONTO THE PUBLIC ROADWAY MUST BE CLEANED OFF BY THE END OF EACH WORK DAY.
 - FAILURE TO COMPLY WITH THE EROSION AND SEDIMENTATION CONTROLS OR REQUIREMENTS CAN RESULT IN A STOP WORK ORDER UNTIL ADEQUATE MEASURES HAVE BEEN CORRECTED TO THE SATISFACTION OF THE APPROVING AUTHORITY.
- SITE SPECIFIC NOTES:**
- MAINTAIN MIN. 2m VEGETATION BUFFER AROUND WETLAND PERIMETER
 - PERMANENT POND CAN BE USED AS A SEDIMENT BASIN PRIOR TO INSTALLATION OF OUTLET PIPE/SPILLWAY.
 - PRIOR TO CONNECTING POND OUTLET PIPE/SPILLWAY:
 - EXCESS SEDIMENTATION TO BE REMOVED FROM POND.
 - RE-ESTABLISH PERMANENT STORM POND DESIGN ELEVATIONS.
 - PROTECT SIDE SLOPES WITH HYDRO-SEED OR A SPRAY EROSION CONTROL

LEGEND:

- DEVELOPMENT PERMIT BOUNDARY
- EXISTING GROUND CONTOURS MINOR - 0.5m INTERVAL
- EXISTING GROUND CONTOURS MAJOR - 1.0m INTERVAL
- DRAINAGE DIVIDES
- DRAINAGE DIVIDE LABEL DRAINAGE DIVIDE AREA IN Ha
- OVERLAND FLOW DIRECTION
- ONSITE/OFFSITE FLOW
- LS ARROW
- SWALE
- SILT FENCE (200.05)
- WETLAND SETBACK
- WETLAND
- SOD
- SPRAY EROSION CONTROL
- SEDIMENT TRAP (200.01)
- VEGETATION
- EX VEGETATION
- CONCRETE WALKWAY/ ASPHALT PATHWAY
- STABILIZED GRAVEL ENTRANCE (200.09)
- RIPRAP (200.10)
- BUILDING (ROOF)
- EXISTING BUILDING

SITE STATISTICS:

TOTAL AREA: 3.29ha
 ZONING: PURD

CRITICAL AREAS:

- WETLAND NORTH OF STRATFORD ROAD
- SURROUNDING RESIDENTIAL DEVELOPMENTS
- WETLAND/PONDS SOUTH OF STRATFORD ROAD

REVISIONS

NO.	DESCRIPTION	DATE	BY

1 ISSUED FOR 90% REVIEW 2024.08 TM

PROJECT: SAMPLE ESC PHASE 1 STRATFORD, PE TOWN OF STRATFORD

DRAWING TITLE: SAMPLE ESC PLAN

CLIENT: TOWN OF STRATFORD

CONSULTANT:

DESIGN BY: TM CHECKED BY: KG PROJECT NO: 20014
 DRAWN BY: LL CHECKED BY: TLL SCALE: 1:500 DATE: 2024.08 DRAWING NO: ESC-01

J:\2024\20014_TownESC\1.0-Planning\3.0-CA\02-Drawings\20014-ESC-Plan.dwg

9.0 STANDARD DETAILS

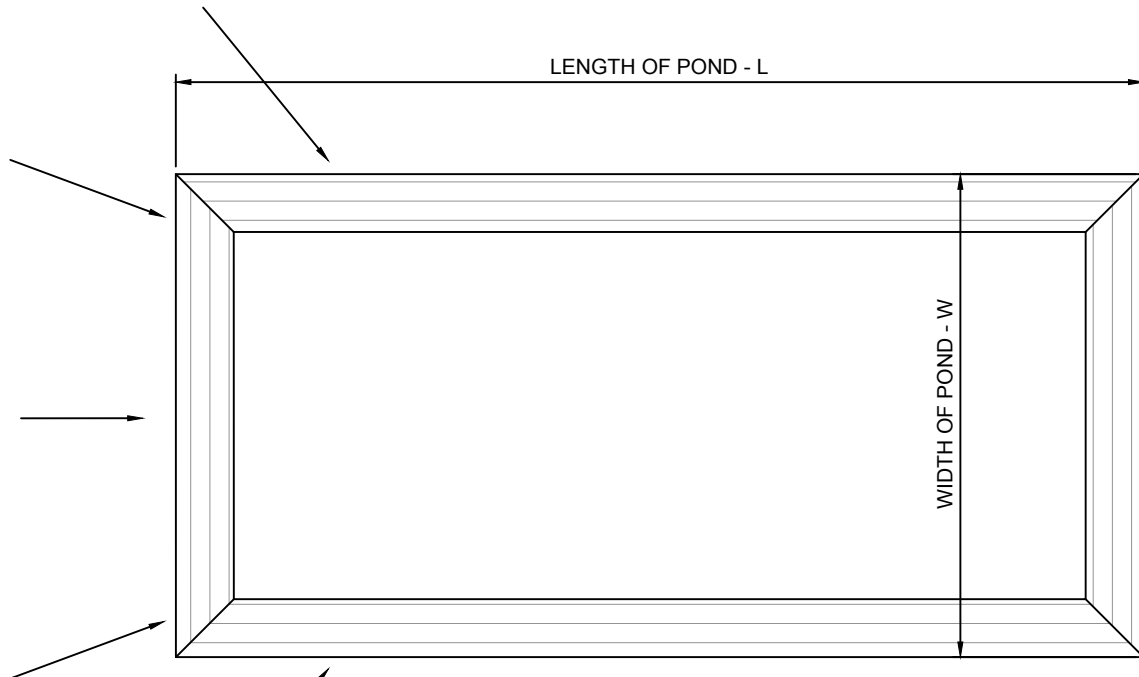

WATER INLET VIA SHEET FLOW AND/OR DIVERSION DITCHES

PLAN

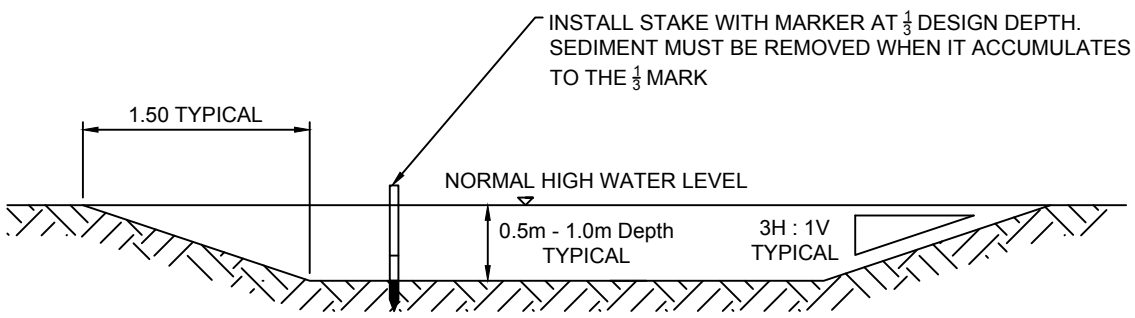

SECTION

NOTES:
 L x W x D MUST BE EQUAL TO VOLUME REQUIRED TO MEET SELECTED P-VALUE.
 BOTTOM OF THE POND MUST BE FLAT.

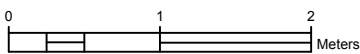

EROSION CONTROL TYPICAL SEDIMENT CONTAINMENT SYSTEM	DATE 2020/04/01	REVISIONS				Sheet No. 1
	SCALE 1:50	No.	DESCRIPTION	DATE		
		02	ISSUED FOR 99% REVIEW	20.04.01	MA	
		01	ISSUED FOR 66% REVIEW	20.03.27	MA	

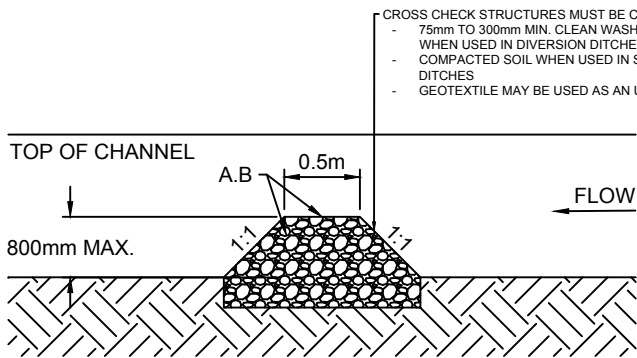

SECTION

CROSS CHECK STRUCTURES MUST BE COMPOSED OF:

- 75mm TO 300mm MIN. CLEAN WASH GRAVEL
- WHEN USED IN DIVERSION DITCHES
- COMPACTED SOIL WHEN USED IN STORAGE DITCHES
- GEOTEXTILE MAY BE USED AS AN UNDERLAY

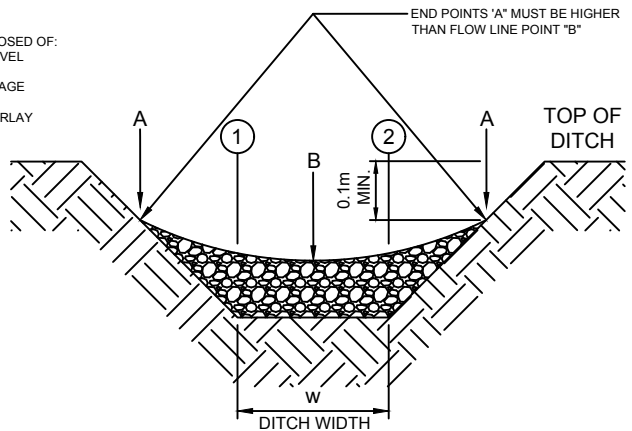

CROSS SECTION

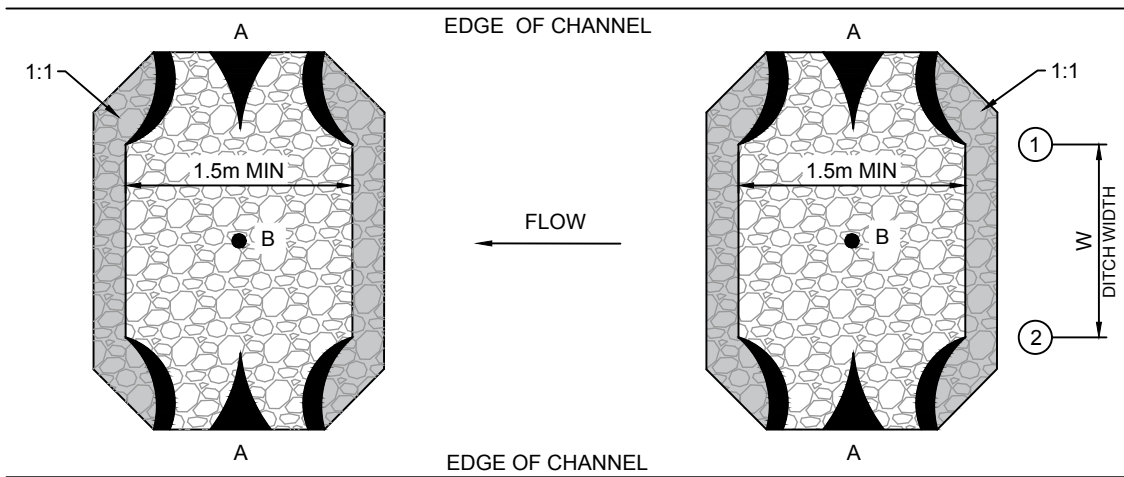

PLAN

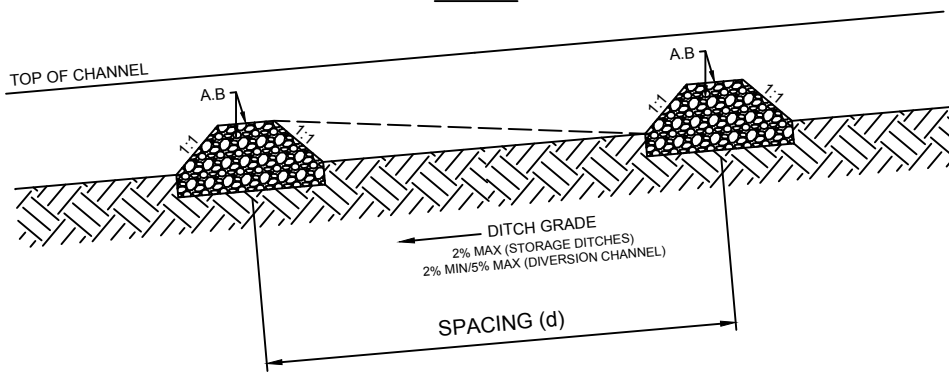

SECTION

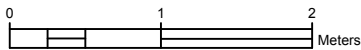

EROSION CONTROL	DATE	REVISIONS				Sheet No.
	2020/04/01	No.	DESCRIPTION	DATE		
CROSS CHECK STRUCTURES	SCALE	02	ISSUED FOR 99% REVIEW	20.04.01	MA	
	1:50	01	ISSUED FOR 66% REVIEW	20.03.27	MA	

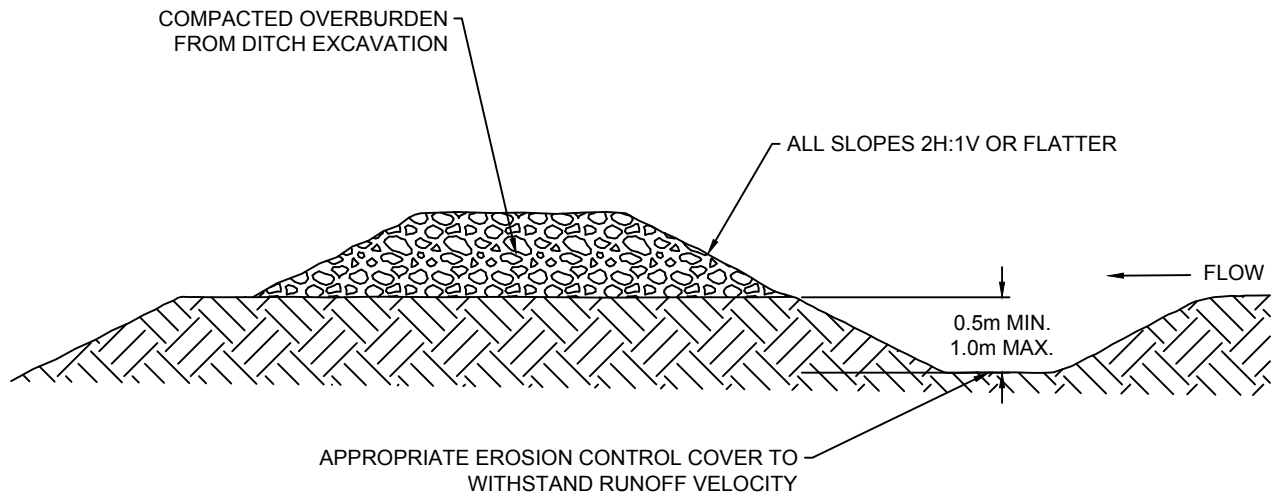



TYPICAL DIVERSION CHANNEL

NOTES:

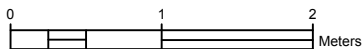
1. THE CHANNEL BEHIND THE DIKE SHALL HAVE POSITIVE GRADE TO A STABILIZED OUTLET
2. DITCH LINE OF DIVERSION CHANNEL MUST BE MINIMUM OF 2% AND A MAXIMUM OF 5% GRADE.



EROSION CONTROL	DATE	REVISIONS					Sheet No. 3
	2020/04/01	No.	DESCRIPTION	DATE	BY		
DIVERSION CHANNEL	SCALE	02	ISSUED FOR 99% REVIEW	20.04.01	MA		
	1:50	01	ISSUED FOR 66% REVIEW	20.03.27	MA		

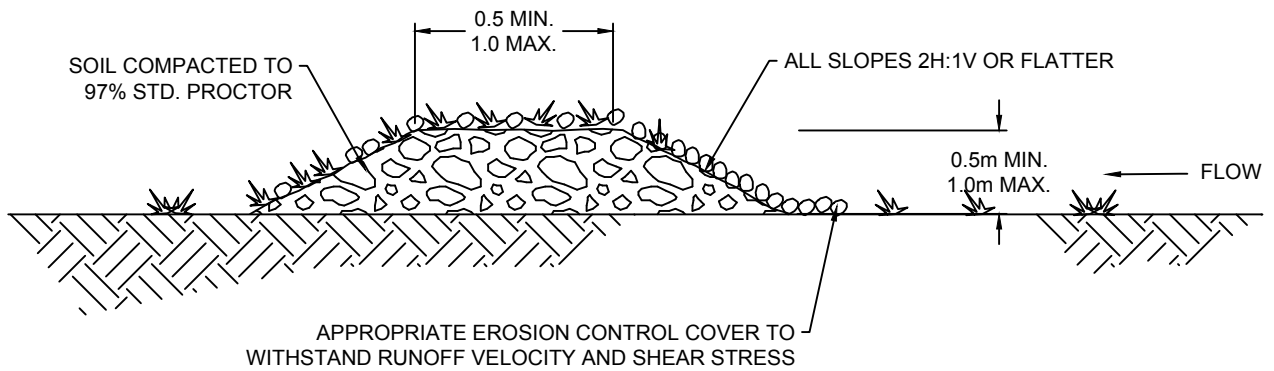

TYPICAL DIVERSION BERM

NOTES:

1. THE BERM SHALL BE STABILIZED IMMEDIATELY WITH APPROPRIATE EROSION CONTROL.

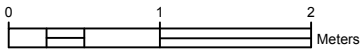

EROSION CONTROL	DATE	REVISIONS			
	2020/04/01	No.	DESCRIPTION	DATE	BY
DIVERSION BERM	SCALE	02	ISSUED FOR 99% REVIEW	20.04.01	MA
	1:50	01	ISSUED FOR 66% REVIEW	20.03.27	MA



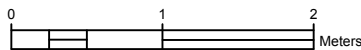
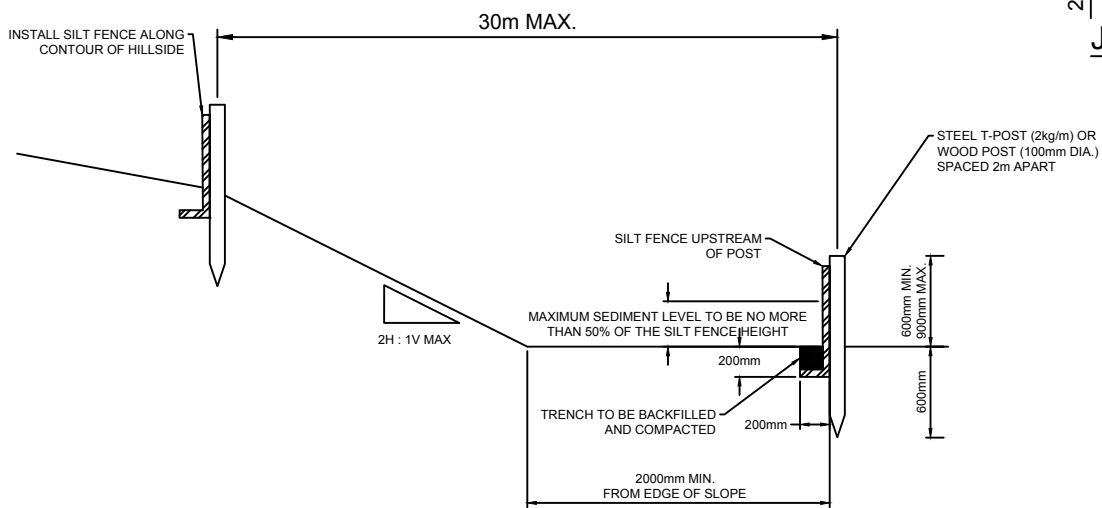
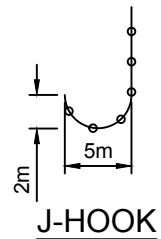
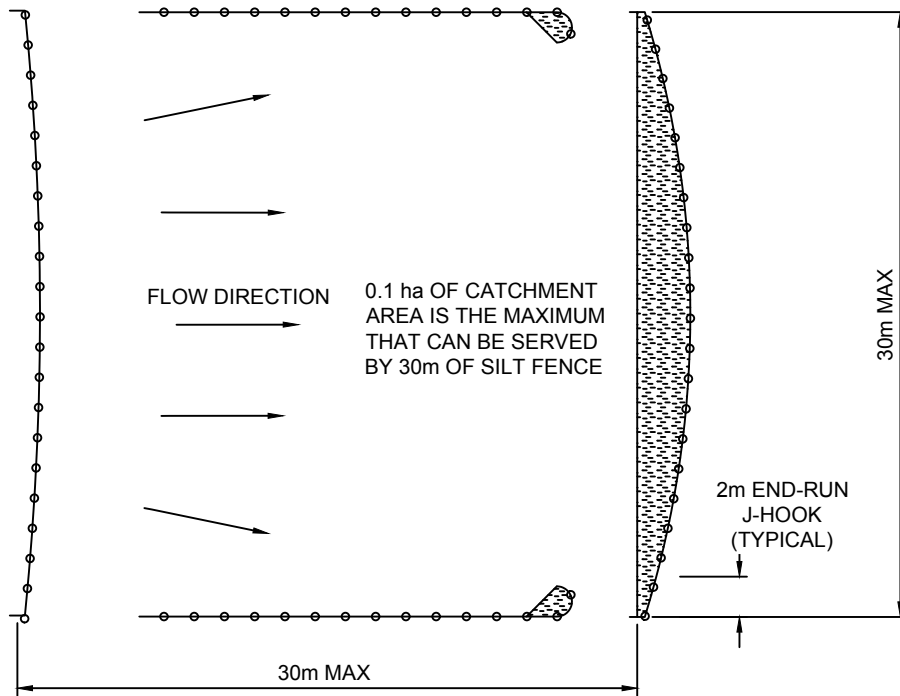

EROSION CONTROL	DATE	REVISIONS				Sheet No.
	2020/04/01	No.	DESCRIPTION	DATE		
SILT FENCE	SCALE	02	ISSUED FOR 99% REVIEW	20.04.01	MA	
	1:50	01	ISSUED FOR 66% REVIEW	20.03.27	MA	

STEP 1:

JOIN SILT FENCE FABRIC ON TO THE POST

SECURELY JOIN SILT FENCE AND WRAP COMPLETELY AROUND POST WITH A 0.4m OVERLAP

NEW SECTION OF SILT FENCE

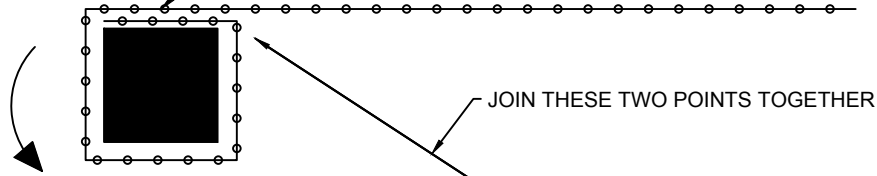

JOIN THESE TWO POINTS TOGETHER

STEP 2:

ONCE SILT FENCE IS SECURED TO EACH POST, JOIN POSTS AND WRAP AROUND EACH OTHER, AT LEAST 1/2 TURN

PREVIOUS SECTION OF SILT FENCE

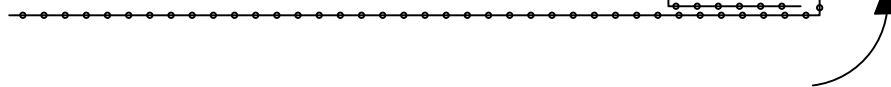

STEP 3:

DRIVE ENTIRE ASSEMBLY INTO THE GROUND

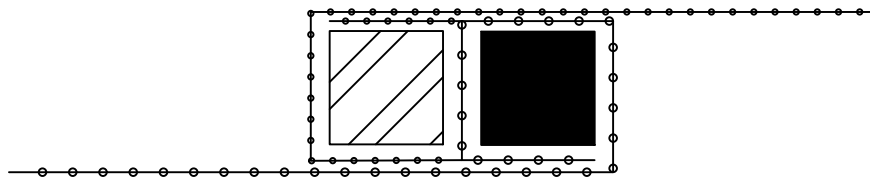

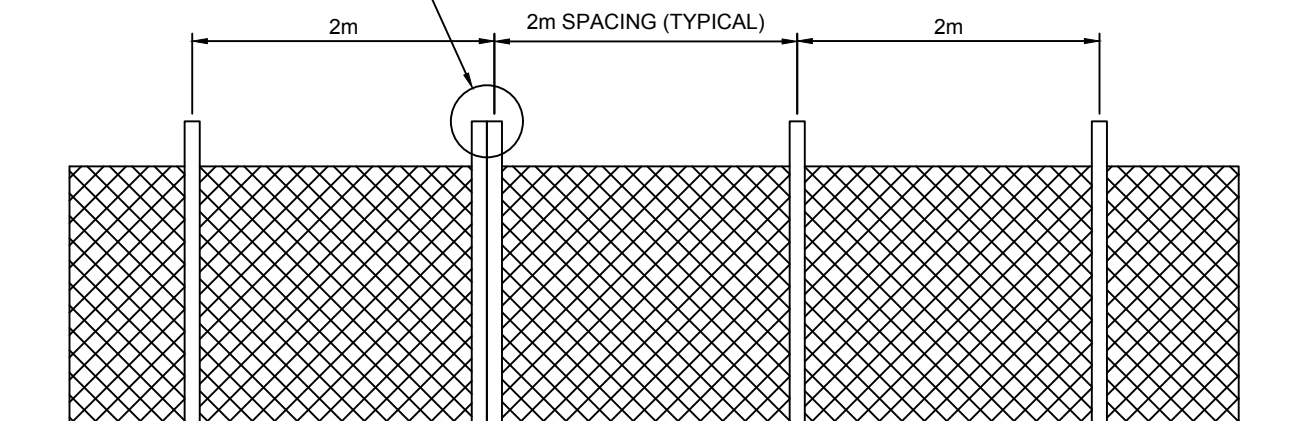

SILT FENCE JOINING - PLAN DETAIL

SEE SILT FENCE JOINING DETAIL

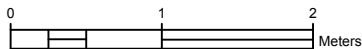

SILT FENCE - FRONT



EROSION CONTROL	DATE	REVISIONS				Sheet No.
	2020/04/01	No.	DESCRIPTION	DATE		
SILT FENCE	SCALE	02	ISSUED FOR 99% REVIEW	20.04.01	MA	
	1:50	01	ISSUED FOR 66% REVIEW	20.03.27	MA	

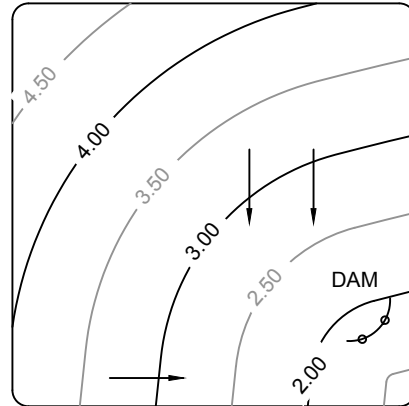
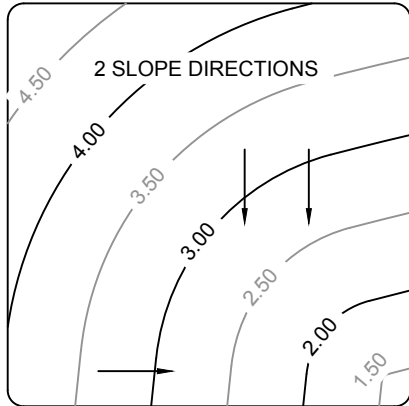

STEP 1 - CONSTRUCT A DAM

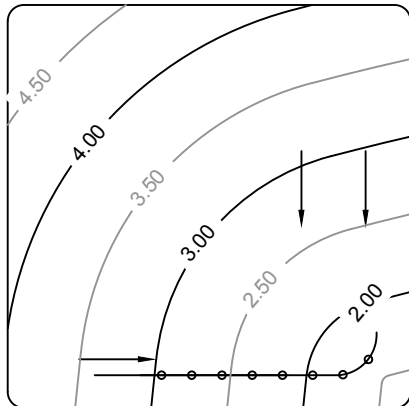

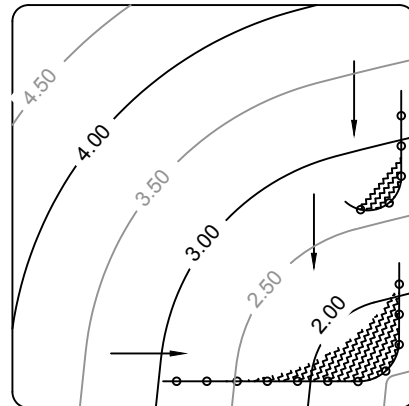

STEP 2 - CONSTRUCT SIDE 2

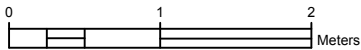

STEP 3 - CONSTRUCT J-HOOKS AS NEEDED

INSTALLATION WITH J-HOOKS WILL INCREASE SILT FENCE EFFICIENCY AND REDUCE EROSION-CAUSING FAILURES.



EROSION CONTROL	DATE	REVISIONS				Sheet No.
	2020/04/01	No.	DESCRIPTION	DATE		
SILT FENCE SLOPE INSTALL	SCALE	02	ISSUED FOR 99% REVIEW	20.04.01	MA	
	1:50	01	ISSUED FOR 66% REVIEW	20.03.27	MA	

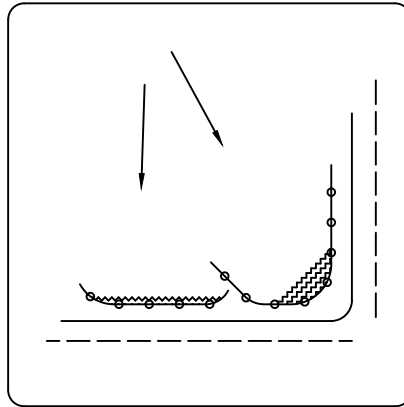

INSTALL J-HOOKS

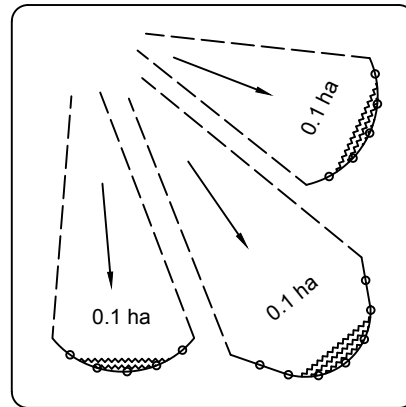
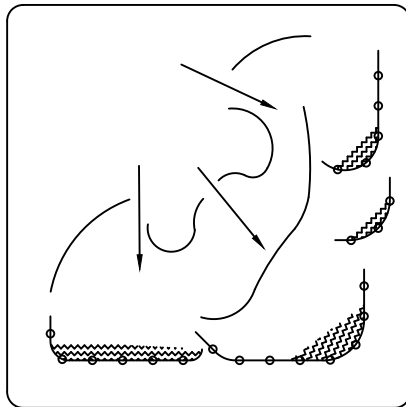

DISCREET SEGMENTS OF SILT FENCE, INSTALLED WITH J-HOOKS WILL BE MUCH MORE EFFECTIVE.

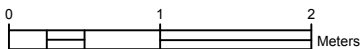

EROSION CONTROL	DATE	REVISIONS				Sheet No.
	2020/04/01	No.	DESCRIPTION	DATE		
SILT FENCE PERIMETER INSTALL	SCALE	02	ISSUED FOR 99% REVIEW	20.04.01	MA	
	1:50	01	ISSUED FOR 66% REVIEW	20.03.27	MA	

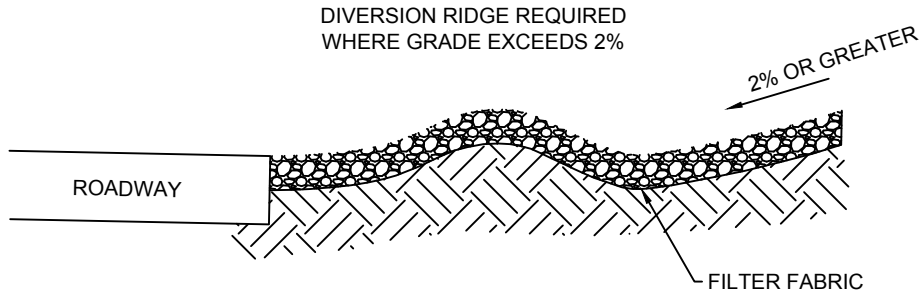

SECTION 'A-A'

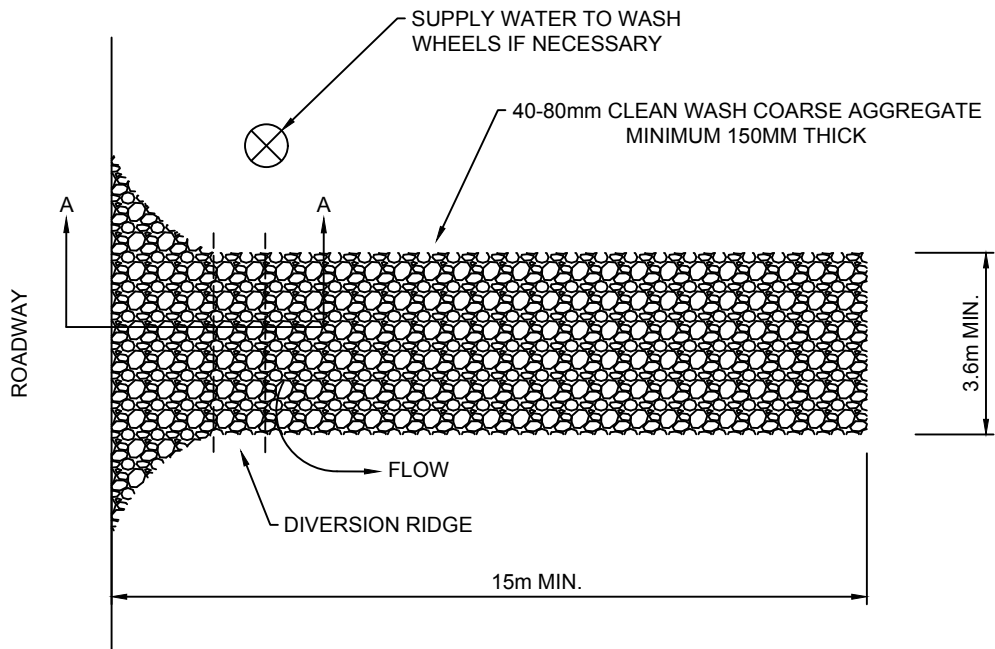

PLAN

NOTES:

1. THE ENTRANCE SHALL BE MAINTAINED IN A CONDITION THAT WILL PREVENT TRACKING OR FLOWING OF SEDIMENT ONTO PUBLIC RIGHT-OF-WAYS. THIS MAY REQUIRE TOP DRESSING, REPAIR AND/OR CLEAN OUT OF ANY MEASURES USED TO TRAP SEDIMENT.
2. WHEN NECESSARY, WHEELS SHALL BE CLEANED PRIOR TO ENTRANCE ONTO PUBLIC RIGHT-OF-WAY.
3. WHEN WASHING IS REQUIRED, IT SHALL BE DONE ON STABILIZED AREA THAT DRAINS INTO AN APPROVED SEDIMENT CONTAINMENT SYSTEM.
4. ALTERNATE SOLUTIONS SUCH AS MUD-MATS MAY BE USED WHEN APPROVED BY THE MUNICIPALITY.

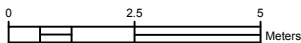

EROSION CONTROL	DATE	REVISIONS			
	2020/04/01	No.	DESCRIPTION	DATE	BY
STABILIZED GRAVEL ACCESS	SCALE 1:150	02	ISSUED FOR 99% REVIEW	20.04.01	MA
		01	ISSUED FOR 66% REVIEW	20.03.27	MA



APPENDIX A:

Stratford Area Watershed Improvement Group Water Sampling Procedure

Water Sampling Procedure

1. Establish baseline TSS levels (Summer 2022)

- 1.1. SAWIG staff will incorporate sampling of known areas of sedimentation into the standard water quality monitoring procedure already in place between May and September.
 - 1.1.1. Biweekly SAWIG staff will use a YSI and flow probe to collect the following data: temperature, dissolved oxygen, total dissolved solids, pH, conductivity, flow (if appropriate).
 - 1.1.2. Biweekly SAWIG staff will collect a water sample using a 1000mL Nalgene sample bottle and will send the sample to the PEI Analytical Lab to be tested for total nitrogen, total phosphorus, and total suspended solids (TSS).
- 1.2. If after summer 2022 the areas of active development begin to impact other waterbodies SAWIG may seek additional funding to establish baseline data for those locations.

2. Monitor heavy rain events

- 2.1. AWIG staff monitors forecast a few days in advance to ensure staff are aware of upcoming heavy rain events.
 - 2.1.1. SAWIG staff ensures Town has sent out notice to builders.
 - 2.1.2. **When possible**, SAWIG staff monitors any known locations that have a risk of runoff. If SAWIG staff is aware of sites without visible controls in place, SAWIG staff will notify Town staff
- 2.2. During a **heavy rain event** occurring during working hours, SAWIG staff visits sites to assess whether runoff is occurring .
 - 2.2.1. If runoff is occurring:
 - 2.2.1.1. SAWIG staff will take a sample with a 1000mL Nalgene sample bottle at point sources of effluent (where runoff is visibly leaving a site) and/or point sources of influent (where runoff is visibly entering a waterway) and sends the samples to the PEI Analytical Lab to be tested for TSS (samples may also be analysed for total nitrogen and total phosphorus).
 - 2.2.1.2. SAWIG staff calls the Provincial Department of Communities Land and Environment to report deleterious substances entering a waterway.
 - 2.2.1.3. SAWIG staff takes photos of **runoff** to provide documentation.
- 2.3. After a heavy rain event and the water bodies are turbid SAWIG staff will take a sample with a 1000mL Nalgene sample bottle and send the samples to the PEI Analytical Lab to be tested for TSS (samples may also be analysed for total nitrogen and total phosphorus).

3. Report effects of runoff events

- 3.1. SAWIG staff receives laboratory results of **runoff** samples and monitors for high levels of TSS and records data.

-
- 3.1.1. When TSS levels are above CCME recommended guidelines (see below), SAWIG staff notifies the Town of Stratford and the Provincial Department of Communities Land and Environment and provides information about the source of the TSS.
- 3.1.2. SAWIG staff follows up with staff from both the Town and the Province to ensure steps are taken to prevent further runoff.

CCME Guidelines

Clear flow: Maximum increase of 25 mg/L from background levels for any short-term exposure (e.g., 24-h period). Maximum average increase of 5 mg/L from background levels for longer term exposures (e.g., inputs lasting between 24 h and 30 d).

High flow: Maximum increase of 25 mg/L from background levels at any time when background levels are between 25 and 250 mg/L. Should not increase more than 10% of background levels when background is ≥ 250 mg/L.